



# ICR Microbial Laboratory Manual



# **ICR MICROBIAL LABORATORY MANUAL**

by

G. Shay Fout, Ph.D., Frank W. Schaefer III, Ph.D., James W. Messer, Ph.D.,  
Daniel R. Dahling and Ronald E. Stetler  
Biohazard Assessment Research Branch  
Human Exposure Research Division  
Cincinnati, Ohio 45268

NATIONAL EXPOSURE RESEARCH LABORATORY  
OFFICE OF RESEARCH AND DEVELOPMENT  
U.S. ENVIRONMENTAL PROTECTION AGENCY  
CINCINNATI, OHIO 45268

## NOTICE

The ICR Microbial Laboratory Manual was prepared by the authors in response to a request from the Office of Water for support in ICR implementation. The methods and laboratory approval components contained in the manual were based upon consensus agreements reached at several workshops attended by industry, academia and U.S. EPA personnel and input from the ICR Microbiology Implementation team, which consisted of U.S. EPA personnel from the Office of Research and Development, Office of Water and representatives from Regional Offices. The manual has been peer reviewed by experts outside of U.S. EPA in accordance with the policy of the Office of Research and Development. Mention of trade names or commercial products does not constitute endorsement or recommendation for use.

## ACKNOWLEDGMENTS

The contributions from Robert S. Safferman, Robert H. Bordner and John A. Winter, the helpful suggestions from members of the ICR Microbiology Implementation Team, the graphical support of Fred P. Williams Jr. and the secretarial assistance of Mary Ann Schmitz and Cordelia Nowell are greatly appreciated.

# TABLE OF CONTENTS

NOTICE .....	ii
ACKNOWLEDGMENTS .....	ii
TABLE OF CONTENTS .....	iii
LIST OF FIGURES .....	vi
LIST OF TABLES .....	vii
SECTION I. INTRODUCTION .....	I-1
BACKGROUND ON THE INFORMATION COLLECTION RULE (ICR) .....	I-1
ENSURING DATA QUALITY FOR THE ICR .....	I-2
SECTION II. LABORATORY QUALITY ASSURANCE PLAN .....	II-1
SECTION III. LABORATORY APPROVAL PROCESS .....	III-1
CERTIFICATION AND LABORATORY APPROVAL PROGRAMS .....	III-1
DESCRIPTION OF APPROVAL PROCEDURE .....	III-1
Application for Approval .....	III-2
Quality Control Samples .....	III-2
Performance Evaluation Samples .....	III-3
On-Site Laboratory Evaluation .....	III-4
Special Approval Requirements .....	III-4
SECTION IV. QUALITY CONTROL .....	IV-1
<i>CLOSTRIDIUM</i> METHOD-SPECIFIC QC .....	IV-1
PROTOZOAN AND VIRUS METHODS-SPECIFIC QC .....	IV-1
Protozoan Methods-Specific Assay Controls .....	IV-1
Virus Monitoring Protocol Assay Controls .....	IV-3
Quality Control Samples .....	IV-4
INTRALABORATORY QC PROCEDURES .....	IV-7
INTERLABORATORY QC PROCEDURES .....	IV-9
RECORDING AND REPORTING QC DATA .....	IV-9
LITERATURE CITED .....	IV-10
SECTION V. ON-SITE LABORATORY EVALUATION .....	V-1
GENERAL EVALUATION CRITERIA .....	V-1
ICR Laboratory Consultant .....	V-1
Evaluation Scheduling .....	V-1

SECTION VI. LABORATORY APPROVAL STATUS .....	VI-1
APPROVAL CLASSIFICATION .....	VI-1
Laboratories .....	VI-1
Principal Analysts/Analysts .....	VI-1
CRITERIA FOR CHANGING APPROVAL STATUS .....	VI-2
Changing Laboratory Approval Status .....	VI-2
Changing Analyst Approval Status .....	VI-2
SYSTEM FOR NOTIFYING UTILITIES OF LABORATORY STATUS .....	VI-5
 SECTION VII. ICR PROTOZOAN METHOD FOR DETECTING <i>GIARDIA</i> CYSTS AND <i>CRYPTOSPORIDIUM</i> OOCYSTS .....	 VII-1
TABLE OF CONTENTS .....	VII-1
PART 1 - SCOPE .....	VII-4
PART 2 - TERMINOLOGY .....	VII-4
PART 3 - SUMMARY OF TEST METHOD .....	VII-5
PART 4 - SIGNIFICANCE AND USE .....	VII-5
PART 5 - INTERFERENCES .....	VII-5
PART 6 - APPARATUS .....	VII-6
PART 7 - REAGENTS .....	VII-8
PART 8 - PRECAUTIONS .....	VII-11
PART 9 - SAMPLING .....	VII-11
PART 10 - ASSAY PROCEDURE .....	VII-17
PART 11 - EDUCATION, TRAINING AND PROFICIENCY .....	VII-32
PART 12 - KEY WORDS .....	VII-33
APPENDIX VII-1. CLEANING THE MANIFOLD AND WELLS .....	VII-34
APPENDIX VII-2. SAMPLE CALCULATION .....	VII-35
APPENDIX VII-3. <i>GIARDIA</i> REPORT FORM .....	VII-37
APPENDIX VII-4. <i>CRYPTOSPORIDIUM</i> REPORT FORM .....	VII-38
APPENDIX VII-5. MICROSCOPE ADJUSTMENTS .....	VII-39
 SECTION VIII. VIRUS MONITORING PROTOCOL FOR THE ICR .....	 VIII-1
TABLE OF CONTENTS .....	VIII-1
PART 1 — SAMPLE COLLECTION PROCEDURE .....	VIII-4
PART 2 — SAMPLE PROCESSING .....	VIII-16
PART 3 — TOTAL CULTURABLE VIRUS ASSAY .....	VIII-23
PART 4 — CELL CULTURE PREPARATION AND MAINTENANCE .....	VIII-30
PART 5 — STERILIZATION AND DISINFECTION .....	VIII-40
PART 6 — BIBLIOGRAPHY AND SUGGESTED READING .....	VIII-43
PART 7 — VENDORS .....	VIII-46
PART 8 — EXAMPLES .....	VIII-48
PART 9 — DATA SHEETS .....	VIII-63

SECTION IX. COLIPHAGE ASSAY .....	IX-1
ASSAY COMPONENTS .....	IX-1
SAMPLE PROCESSING .....	IX-2
SOMATIC COLIPHAGE ASSAY .....	IX-2
MALE-SPECIFIC COLIPHAGE ASSAY .....	IX-5
 SECTION X. MEMBRANE FILTER METHOD FOR <i>E. coli</i> .....	 X-1
 SECTION XI. MEMBRANE FILTRATION METHOD FOR <i>C. perfringens</i> .....	 XI-1
 APPENDIX A. VERIFICATION OF STATE CERTIFICATION .....	 ApA-1
 APPENDIX B. APPLICATION FOR LABORATORY APPROVAL .....	 ApB-1
MINIMAL REQUIREMENTS FOR VIRUS LABORATORIES .....	ApB-2
MINIMAL REQUIREMENTS FOR PROTOZOAN LABORATORIES .....	ApB-9
 APPENDIX C. CHECKLIST FOR LABORATORY APPROVAL FOR <i>GIARDIA</i> AND <i>CRYPTOSPORIDIUM</i> .....	  ApC-1
 APPENDIX D. CHECKLIST FOR LABORATORY APPROVAL FOR TOTAL CULTURABLE VIRUS .....	  ApD-1
SECTION I - LABORATORY-SPECIFIC INFORMATION .....	ApD-2
SECTION II - ANALYST-SPECIFIC INFORMATION .....	ApD-11
DESCRIPTION OF CHECKLIST FOR LAB APPROVAL FOR VIRUS ANALYSIS .....	 ApD-13

## LIST OF FIGURES

FIGURE VI-1. ICR - Microbiology Decision Tree . . . . .	VI-3
FIGURE VI-2. Criterion #1 Decision Tree . . . . .	VI-4
FIGURE VI-3. Criterion #2 Decision Tree . . . . .	VI-6
FIGURE VII-1. Raw Water Sampling Apparatus . . . . .	VII-13
FIGURE VII-2. Finished Water Sampling Apparatus . . . . .	VII-14
FIGURE VII-3. Ten-Place Manifold with Stainless Steel Wells . . . . .	VII-21
FIGURE VII-4. Ten-Place Hoefer Manifold Membrane Labeling Diagram . . . . .	VII-23
FIGURE VII-5. Methods for Scanning Water Filter Membrane . . . . .	VII-29
FIGURE VIII-1. Standard Filter Apparatus . . . . .	VIII-5
FIGURE VIII-2. Additional Modules for the Standard Filter Apparatus . . . . .	VIII-9
FIGURE X-1. Precision Estimates for <i>E. coli</i> in Water by the M-TEC Method . . . . .	X-11

## LIST OF TABLES

TABLE IV-1. Reagent Grade Water Purity Parameters .....	IV-9
TABLE VII-1. Ethanol/Glycerol Series .....	VII-10
TABLE VIII-1. Guide for Preparation of BGM Stock Cultures .....	VIII-36
TABLE VIII-2. Preparation of Virus Assay Cell Cultures .....	VIII-37
TABLE VIII-3. Water Quantity to be Added to Vessels during Autoclaving .....	VIII-41
TABLE XI-1. Sample Volume to Obtain Colony Count on Membrane Filters .....	XI-11
TABLE XI-2. Statistical Evaluation of Results (CFU/100 mL) .....	XI-13



## SECTION I. INTRODUCTION

### BACKGROUND ON THE INFORMATION COLLECTION RULE (ICR)

The United States Environmental Protection Agency (U.S. EPA) instituted a formal regulation negotiation process in 1992 to develop the Disinfectant/Disinfection By-Product (D/DBP) Rule.<sup>1</sup> The Advisory Committee that was established to negotiate the regulation included representatives from the water industry, State health agencies, environmental groups, consumer groups, and the U.S. EPA. During negotiations, the Advisory Committee realized that setting strict limits on the levels of disinfectants and disinfection by-products (D/DBPs) in drinking water could result in increasing risk of waterborne disease from pathogens. To balance the risks from pathogens and chemicals, the Advisory Committee made several recommendations and the final result was the development of three new drinking water regulations.

The Disinfectant/Disinfection By-Product Rule was the primary rule negotiated. The Advisory Committee recommended a two step approach to regulating the D/DBPs with the first stage of the regulation coinciding with a regulation to ensure microbial safety of the water. The Stage 1 D/DBP Rule: 1) sets limits on the amount of disinfectants allowed in drinking water; 2) reduces the limits on total trihalomethanes (TTHMs) from 100  $\mu\text{g/L}$  to 80  $\mu\text{g/L}$ ; 3) sets limits on additional DBPs (sum of five haloacetic acids [HAA5], chlorite, and bromate); 4) requires the use of enhanced coagulation by utilities treating surface water containing total organic carbon (TOC) concentrations above certain levels; and 5) applies to all community and non-transient noncommunity water systems.

The second rule developed during the negotiation process is the Enhanced Surface Water Treatment Rule (ESWTR). It specifies levels of treatment to control pathogens in drinking water based on microbial quality of the source water. This rule would become effective at the same time as the Stage 1 D/DBP Rule.

The third rule that was recommended by the Advisory Committee is the Information Collection Requirements Rule (ICR). This rule addresses data needs in three areas.

The most critical element of the ICR involves the collection of data on the concentrations of specific microbes. *Cryptosporidium*, *Giardia* and total culturable viruses are being monitored in surface waters that are used to produce drinking water and in drinking water, when high concentrations are found in surface water. In addition, data are being collected on the concentrations of indicators of human pollution in these waters. The data collected during the ICR will be used in the development of the ESWTR.

---

<sup>1</sup>57 FR 53866, November 13, 1992

The second element of the ICR involves the collection of treatment plant operational data and monitoring of the source water and drinking water for general water quality characteristics, DBPs, and surrogates for DBPs and DBP precursors. These data from the ICR will be used to: 1) characterize the source water parameters that influence DBP formation; 2) determine concentrations of DBPs in drinking water; 3) refine models for predicting DBP formation; and 4) establish cost-effective monitoring techniques. Development of the Stage 2 D/DBP rule is dependent upon analyses of these data.

The third element of the ICR requires some systems to conduct bench or pilot scale studies on DBP precursor removal using either granular activated carbon or membrane filtration. The purposes of these Precursor Removal/ICR studies are: 1) to obtain more information on the cost effectiveness of these technologies for reducing DBP levels; and 2) to decrease the time systems would need to install such technology, if it was required under a Stage 2 D/DBP rule.

### ENSURING DATA QUALITY FOR THE ICR

One of the major issues during development of the ICR concerned the quality of the data that would be generated during the monitoring period. The Advisory Committee recognized that the data must be both accurate and precise to meet the ICR objectives. Everyone realized the difficulty in ensuring data quality considering that the data are to be generated by many laboratories. Maintaining data comparability between laboratories would be necessary to use the data for sophisticated correlational analyses and to have data that are useful for predicting DBP formation as a function of water quality conditions. The Advisory Committee felt that the only way to ensure that useable data is obtained is for the U.S. EPA to assist the drinking water industry in identifying qualified laboratories for performing the analyses required by the ICR.

In August 1993, U.S. EPA convened a technical workgroup to assist in developing approaches for ensuring microbiological data quality. Representatives from utility, state and commercial laboratories were present at the three day meeting. Persons were invited to this meeting based on their expertise in one or more of the following areas: 1) analyzing for microorganisms; 2) day-to-day management of laboratory operations; and 3) drinking water laboratory certification programs.

The technical workgroup made several general recommendations on approaches to ensure data quality. These recommendations were included in the proposed ICR.<sup>2</sup> The workgroup's recommendations and public comments to the proposed rule were used by the U.S. EPA to develop this manual.

---

<sup>2</sup>59 FR 6332, February 10, 1994

## SECTION II. LABORATORY QUALITY ASSURANCE PLAN

All laboratories analyzing samples for the ICR will be required to adhere to defined quality assurance procedures to ensure that generated analytical data are scientifically valid and are of known and acceptable precision and specificity. To facilitate the accomplishment of these goals, each laboratory must have a written description of its quality assurance activities, a QA plan, describing the QA management of day to day routine operations. The plan must be available for inspection for ICR laboratory approval and during the time which the laboratory is performing ICR measurements.

The laboratory's QA plan should be a separately prepared text. However, documentation for some of the listed QA plan items can be made by reference to appropriate documents, such as the laboratory's SOPs, U.S. EPA Methods, or to **Standard Methods for the Examination of Water and Wastewater**. Laboratories currently certified for coliform analyses under the Drinking Water Certification program may use their current QA Plan for ICR bacteriological monitoring. Items pertinent to the protozoan or virus analyses may be placed in an addendum. This addendum must contain all the QC criteria for these analyses.

The following items should be addressed in each QA plan:

### LABORATORY ORGANIZATION AND RESPONSIBILITY

1. Include a chart showing the laboratory organization and line authority, including QA Managers.
2. List the key individuals who are responsible for ensuring the production of valid measurements and the routine assessment of QC measurements
3. Specify who is responsible for internal audits and reviews of the implementation of the QA plan and its requirements.

### PERSONNEL

1. List analysts' academic background and water analysis experience.
2. Describe training available to keep personnel up to date on regulations, methods and/or TQM.

### FACILITIES

Describe the following:

1. Arrangement and size of laboratories
2. Bench space
3. Storage space
4. Lighting

5. Air system
6. Lab reagent water system
7. Waste disposal system
8. Safety considerations

### FIELD SAMPLING PROCEDURES

1. Identify samples collected, describe how samples are collected, sample containers, holding, transport times, and temperature.
2. Describe sample identification and information recording system, chain-of-custody procedure, if applicable.

### LABORATORY SAMPLE HANDLING PROCEDURES

1. Describe sample storage conditions.
2. Describe the laboratory's sample tracking system; specify procedures used to maintain the integrity of all samples, i.e., logging, tracking samples from receipt by laboratory through analysis to disposal.

### EQUIPMENT

For each equipment item describe the following:

1. Specifications
2. Calibration procedures, frequency, standards
3. Quality control records
4. Preventive maintenance and schedules, documentation

### SUPPLIES

Describe the specifications for major supplies, including storage conditions for reagents and media:

1. Laboratory glassware and plasticware
2. Chemicals, reagents, dyes and culture media
3. Filters

### LABORATORY PRACTICES

Describe the following practices:

1. Preparation of reagent-grade water
2. Glassware washing and preparation

3. Sterilization procedures

### ANALYTICAL PROCEDURES

1. Describe all reference methods used
2. State that the analytical methods described in this manual will be followed
3. Identify available SOPs

### QUALITY CONTROL (QC) CHECKS

Describe how the following are performed:

1. Confirmation/verification procedures, frequency
2. Sterility controls
3. Replicate analyses; frequency
4. QC samples, source; frequency
5. PE samples, source; frequency
6. Spiked samples
7. Between analyst deviation

### DATA REDUCTION, VERIFICATION, VALIDATION AND REPORTING

Describe the procedures for the following:

1. Data reduction, e.g., conversion of raw data to mg/L., coliforms/100 mL, etc.
2. Ensuring the accuracy of data transcription and calculations.
3. Validation, e.g., how are ICR QC requirements met?
4. Reporting, including procedures and format for reporting data to utilities/EPA

### CORRECTIVE ACTION CONTINGENCIES

1. Define the laboratory response to obtaining unacceptable results from PE or QC samples and from internal QC checks
2. Identify persons with responsibility to take corrective action
3. Describe how the actions taken and the effectiveness of the actions taken will be documented

### RECORD KEEPING

1. Describe how records are to be maintained (e.g., electronically, hard copy, etc.)
2. Describe how long records are to be kept.
3. State where records are to be stored.

A laboratory QA plan should be concise but responsive to the above-listed items. Minimizing paperwork while improving dependability and quality of data are the intended goals. **"Preparation Aids for the Development of Category I Quality Assurance Plans,"** EPA/600/8-91/003, is a document laboratories may find useful in preparing a QA plan for the ICR. It can be obtained by calling the National Risk Management Research Laboratory, Technical Information Branch at 513-569-7562. Not all of the above sections are described in the project plan guidance (i.e., laboratory sample handling and record keeping) and the goals of a lab QA Plan in general are different from the goals of a QAPP. The former describes QA Management of day to day routine operations and the latter describes goals, interactions and procedures for a specific project. By adding to the QA lab plan what will be done to meet ICR criteria, the lab will develop a Project Plan for the ICR responsibilities.

## SECTION III. LABORATORY APPROVAL PROCESS

### CERTIFICATION AND LABORATORY APPROVAL PROGRAMS

Laboratories requesting approval to perform quantitative analyses for total coliforms and fecal coliforms or *E. coli* in source and drinking water for the ICR must be certified under the drinking water laboratory certification program as specified by **40 CFR 142.10(b)(4)** and **141.28**. In this program, the U.S. EPA certifies the principal State laboratory and with certain exceptions other laboratories in non-primacy states (**40 CFR 142.10**). Each State certifies all other drinking water laboratories within the State.

Laboratories that will perform quantitative analyses for total coliforms and fecal coliforms or *E. coli* in source water and drinking water must provide validation of certification under the drinking water laboratory certification program. These laboratories are requested to complete the Verification of State Certification form (**Appendix A**) and return the form to the U.S. EPA Office listed.

The drinking water laboratory certification program does not address analyses for the pathogens of relevance to the ICR — *Giardia*, *Cryptosporidium* and total culturable viruses. Rather than broaden the drinking water laboratory certification program to cover these organisms, U.S. EPA has developed a separate program for the ICR, using the term "laboratory approval" rather than "laboratory certification."

The final ICR Rule does not require that water systems monitor for *Clostridium* or coliphage and these organisms are not included in the laboratory approval program. However, water systems may monitor for them and submit their data to the ICR database. If this option is chosen, the methods and QC conditions described in this manual should be followed.

A major difference between the drinking water laboratory certification and laboratory approval programs is that the latter requires that certain laboratory personnel be individually approved. All principal analysts must be approved for protozoan analyses (*Giardia* and *Cryptosporidium*). All principal analysts and all analysts must be approved for analysis of total culturable viruses. Each approved laboratory and each individual who must be individually approved will be assigned a unique identification (ID) number or code.

### DESCRIPTION OF APPROVAL PROCEDURE

Laboratory approval will require: (1) submission and acceptance of an application for approval, (2) satisfactory analyses of unknown Performance Evaluation (PE) samples; and (3) passing an on-site laboratory evaluation.

The term "analyst" will be used in the remainder of this section to refer to all principal analysts and analysts who must be individually approved. Only these analysts must obtain

successful performance with PE samples. They will also be required to demonstrate method proficiency during the on-site visit.

### **Application for Approval:**

The laboratory approval process for pathogen testing will begin when the laboratory director makes a formal request for approval to the:

ICR Laboratory Coordinator  
U.S. EPA, Office of Ground Water & Drinking Water  
Technical Support Division  
26 West Martin Luther King Drive  
Cincinnati, OH 45268

Upon receipt of the formal request for approval, the U.S. EPA Laboratory Coordinator will provide the requesting laboratory an application form to be completed and returned. Only laboratories that meet the minimal facility, equipment and personnel requirements described in the application package will be considered for approval. The application package is reproduced as **Appendix B**.

Laboratories will be notified in writing when their application for approval is accepted. Laboratories meeting the minimal requirements will receive one copy each of the appropriate sampling and methods videos and their accompanying guides and a copy of this manual. In addition, U.S. EPA will provide buffalo green monkey kidney (BGM) cells and an MPN computer program to all laboratories meeting minimal requirements for virus analyses. All laboratories meeting minimal requirements for protozoan analyses will be supplied a spreadsheet for calculating *Giardia* cyst and *Cryptosporidium* oocyst concentrations. The supplied cell line and computer programs must be used during ICR monitoring to ensure uniform results.

### **Quality Control Samples:**

Quality Control (QC) samples containing known *Giardia* cyst, *Cryptosporidium* oocyst and virus concentrations will be provided to analysts requesting approval. These samples, which are described in detail in **Section IV**, may be used for internal QC checks and to gain method proficiency. Successful analyses on QC samples will be required for ongoing approval during the ICR monitoring period. The data from QC samples for ongoing approval must be entered into an ICR Laboratory Quality Control System software developed to track QC data and sent monthly in electronic form to the ICR Data Center at the address given below. The package containing the diskette with QC data must be postmarked no later than the last day of each month.



U.S. EPA (ICR4600)  
ICR Data Center  
Room 1111 East Tower  
401 M Street, SW  
Washington, D.C. 20460

### **Performance Evaluation Samples:**

Under the laboratory approval program, qualified laboratory personnel must analyze satisfactorily PE sample sets to become approved and then subsequent sets every month to maintain approval. Each analyst must process the PE samples for *Giardia/Cryptosporidium* or total culturable viruses as normal samples as described in the method protocols (**Section VII** and **Section VIII**, respectively). While personnel who do not have to be individually approved are not required to analyze PE samples, they must process the same portions of PE samples for analysts that they would for actual water samples to be tested. A hard copy of the PE data must be sent directly to the ICR Laboratory Coordinator at the address listed above. The hard copy of the data must not include the laboratory name, address or any other identifying information. This information should be included only on a cover letter accompanying the data.

A set of PE samples for initial approval will have seven to ten samples. For laboratories analyzing protozoan samples, PE samples will consist of 1  $\mu\text{m}$  nominal porosity filters containing either a blank synthetic matrix or a mixture of *Giardia* cysts and *Cryptosporidium* oocysts in various concentrations in a synthetic matrix. For laboratories analyzing virus samples, PE samples will consist of 1MDS filters containing either a blank synthetic matrix or attenuated poliovirus type 3 in various concentrations in a synthetic matrix.

A set of PE samples for ongoing approval will have two samples. The samples types will be the same as for initial approval. Conditions for maintaining ongoing approval are described in **Section VI**.

A standard statistical method will be used to determine the mean concentrations, variation and pass/fail acceptance limits for PE samples using either data from reference laboratories or overall data for each lot from all laboratories.

If an analyst fails the initial PE sample set, the analyst will have a second chance with another sample set within three months. Analysts who fail PE samples should contact the ICR Laboratory Coordinator for suggestions on remedies for the problem, since failure to meet acceptance levels on a second PE sample set will result in the analyst being excluded from the program.

## **On-Site Laboratory Evaluation:**

The primary purpose of the laboratory on-site evaluation is to ensure valid data. The immediate objective is to evaluate the facilities and equipment of the laboratory and the analyst's ability to adhere to the monitoring protocols. The use of uniform methodology makes it possible to compare data generated by the different laboratories. The laboratory evaluation criteria that will be used during site visits is given in **Section V**.

## **Special Approval Requirements:**

### 1. Sample Collections:

Appropriate sample collection is an important part of the ICR process. Sample collectors will be provided a videotape and accompanying guide describing the specified sampling procedures by the U.S. EPA. Although sample collection will be performed by the utility, the analytical laboratory must supply the utility with properly cleaned or sterile sampling apparatus modules and assist the sample collectors by providing information and guidance on the procedures and proper use of equipment to ensure sample integrity.

### 2. Sample Archiving:

By applying for U.S. EPA approval for virus analyses, a laboratory agrees to prepare virus archive samples as described in the Virus Monitoring Protocol (see **Section VIII**).

Each water system will notify its contracted virus analytical laboratory when the following conditions trigger archiving requirements:

- a. Virus detection in finished water: when a system learns that viruses were detected in any previous finished water sample, all subsequent source and finished water samples must be archived for the remainder of the ICR monitoring period.
- b. Virus detected at a level of 10,000 MPN units per 100 L (approximately 100 infectious virus particles per liter) in source water: when a system learns that viruses were detected in any previous source water sample at this density, all subsequent source and finished water samples must be archived for the remainder of the ICR monitoring period.

Archive samples must be frozen at  $-70^{\circ}\text{C}$  and shipped on dry ice to the ICR Laboratory Coordinator at the address listed above; however, the samples may be stored by the analytical laboratory at  $-70^{\circ}\text{C}$  and shipped periodically to the U.S. EPA as a batch.

## SECTION IV. QUALITY CONTROL

Laboratories that perform microbiological analyses for the ICR are required to use the methods contained in this manual. These methods identify methods-specific quality control (QC) procedures which must be followed to ensure accurate and precise data. In addition to methods-specific QC procedures, laboratories must practice intralaboratory QC, the day-to-day checks made on internal operations, and interlaboratory QC, the maintenance of minimal standards established among a group of participating laboratories.

The following are descriptions of ICR methods-specific, intralaboratory, and interlaboratory QC procedures.

### CLOSTRIDIUM METHOD-SPECIFIC QC

Analytical laboratories are responsible for developing their own internal QC program and must run positive and negative controls as described in **Section XI** (subsection 9.4). U.S. EPA will not supply QC samples.

### PROTOZOAN AND VIRUS METHODS-SPECIFIC QC

A U.S. EPA contractor will prepare and ship QC stock suspensions of *Giardia lamblia* cysts and *Cryptosporidium parvum* oocysts and both high-titered and low-titered QC samples of attenuated poliovirus type 3. Upon arrival, the protozoan QC samples must be stored at 4°C and the virus QC samples at -70°C. The protozoan QC stock suspensions and the high-titered poliovirus sample may be used to gain proficiency with the methods and for the development of the laboratory's own QC tests. Methods-specific QC procedures will require that the protozoan stock suspensions be diluted. Instructions for dilution will accompany the suspensions.

#### **Protozoan Methods-Specific Assay Controls:**

The purpose of these controls is to assure that the assay reagents for the **ICR Protozoan Method For Detecting *Giardia* Cysts and *Cryptosporidium* Oocysts In Water By A Fluorescent Antibody Procedure** (see **Section VII**) are functioning, that the assay procedures have been properly performed, and that the microscope has been adjusted and aligned properly.

#### A. Membrane Filter Preparation:

Use the INDIRECT FLUORESCENT ANTIBODY PROCEDURE to prepare at least one positive and one negative IFA control for *Giardia* cysts and *Cryptosporidium* oocysts each time the manifold is used.

B. Negative IFA Control for *Giardia/Cryptosporidium*:

Step 1. Add 1.0 mL 1X PBS to one well of the manifold containing a Sartorius cellulose acetate filter on top of a membrane support filter. Perform the **Indirect Fluorescent Antibody Staining** and **Filter Mounting** steps.

Step 2. Using epifluorescence, scan the negative control membrane at no less than 200X total magnification for apple-green fluorescence of *Giardia* cyst and *Cryptosporidium* oocyst shapes.

Step 3. If no apple-green fluorescing cyst or oocyst shapes are found, and if background fluorescence of the membrane is very dim or non-existent, continue with examination of the water sample slides.

If apple-green fluorescing cyst or oocyst shapes are found, discontinue examination since possible contamination of the other slides is indicated. Clean the equipment, recheck the reagents and procedure and repeat the assay using additional aliquots of the sample.

C. Positive IFA Control for *Giardia/Cryptosporidium*:

Step 1. Add 500-1000 *Giardia lamblia* cysts and 500-1000 *Cryptosporidium parvum* oocysts or the Ensys positive control antigen (as specified in the kit) to one well of the manifold containing a Sartorius cellulose acetate filter on top of a membrane support filter. Perform the **Indirect Fluorescent Antibody Staining** and **Filter Mounting** steps.

Step 2. Using epifluorescence, scan the positive control slide at no less than 200X total magnification for apple-green fluorescence of *Giardia* cyst and *Cryptosporidium* oocyst shapes. Background fluorescence of the membrane should be either very dim or non-existent. *Cryptosporidium* oocysts may or may not show evidence of oocyst wall folding, which is characterized under epifluorescence by greater concentrations of FITC along surface fold lines, depending upon the manner in which the oocysts have been treated, and the amount of turgidity they have been able to maintain.

If no apple-green fluorescing *Giardia* cyst or *Cryptosporidium* oocyst shapes are observed, then the fluorescent staining did not work or the positive control cyst preparation was faulty. Do not examine the water sample slides for *Giardia* cysts and *Cryptosporidium* oocysts. Recheck reagents and procedures to determine the problem.

Step 3. If apple-green fluorescing cyst and oocyst shapes are observed, change the microscope from epifluorescence to the 100X oil immersion Hoffman modulation® or differential interference contrast objective.

At no less than 1000X total oil immersion magnification, examine *Giardia* cyst shapes and *Cryptosporidium* oocyst shapes for internal morphology.

The *Giardia* cyst internal morphological characteristics include one to four nuclei, axonemes, and median bodies. *Giardia* cysts should be measured to the nearest 0.5 µm with a calibrated ocular micrometer. Record the length and width of the cysts and the morphological characteristics observed. Continue until at least three *Giardia* cysts have been detected and measured in this manner.

The *Cryptosporidium* oocyst internal morphological characteristics include one to four sporozoites. Examine the *Cryptosporidium* oocyst shapes for sporozoites and measure the oocyst diameter to the nearest 0.5 µm with a calibrated ocular micrometer. Record the size of the oocysts and the number, if any, of the sporozoites observed. Sometimes a single nucleus is observed per sporozoite. Continue until at least three oocysts have been detected and measured in this manner.

#### **Virus Monitoring Protocol Assay Controls :**

A. Negative Assay Control for the **Virus Monitoring Protocol for the ICR** (see **Section VIII**): Inoculate a BGM culture with 0.15 M sodium phosphate, pH 7.0-7.5, using the procedures in **Section VIII, Part III — Total Culturable Virus Assay** . Do not report data from associated water samples if positive CPE is obtained in this control. Do not process any more samples until the reason(s) for the positive result is determined.

B. Positive Assay Control for the **Virus Monitoring Protocol for the ICR** (see **Section VIII**): Inoculate a BGM culture with 0.15 M sodium phosphate, pH 7.0-7.5, containing 20 PFU of attenuated poliovirus type 3, using the procedures in **Section VIII, Part III — Total Culturable Virus Assay** . Do not report data from associated water samples if CPE is not observed in this control. Do not process any more samples until the reason(s) for the negative result is determined.

C. Negative Assay Control for the optional **Coliphage Assay** (see **Section IX**): Add 1 mL of buffered 1.5% beef extract to a 16 x 150 mm test tube. Continue with **Step 2** of the **Procedure for Somatic or Male-Specific Coliphage Assay** . Do not report data from associated water samples if plaques are observed in this control. Do not process any more samples until the reason(s) for the positive result is determined.

D. Positive Assay Control for the optional **Coliphage Assay** (see **Section IX**): Add 1 mL of the diluted somatic or male-specific positive control to another 16 x 150 mm test tube. Continue with **Step 2** of the **Procedure for Somatic or Male-Specific Coliphage Assay** . Do not report data from associated water samples if the positive control counts are more than one log below their normal average. Do not process any more samples until the reason(s) for the below normal positive result is determined.

## Quality Control Samples:

### A. *Giardia* cyst and *Cryptosporidium* Oocyst Quality Control Samples:

1. Negative QC Sample Preparation: This control is a check on equipment, materials, reagents and technique. It involves processing a 1 µm nominal porosity cartridge filter as if it were an unknown using the indicated procedures from the **ICR Protozoan Method for Detecting *Giardia* Cysts and *Cryptosporidium* Oocysts in Water by a Fluorescent Antibody Procedure** (see **Section VII**).

Step 1. Process a 1 µm nominal porosity cartridge filter using the FILTER ELUTION AND CONCENTRATION, FLOTATION PURIFICATION and INDIRECT FLUORESCENT ANTIBODY procedures in **Section VII**.

Step 2. Examine the entire concentrate for *Giardia* cysts and *Cryptosporidium* oocysts using the **Microscopic Examination** procedure of **Section VII**. If any cysts or oocysts are detected, do not process any more unknown samples until the source(s) of the contamination is located and corrected.

2. Positive QC *Giardia* and *Cryptosporidium* Sample Preparation: The purpose of this control is to assure that the laboratory can recover cysts and oocysts with the indicated procedures from the **ICR Protozoan Method for Detecting *Giardia* Cysts and *Cryptosporidium* Oocysts in Water by a Fluorescent Antibody Procedure** (see **Section VII**) when they are spiked into a sample at a known level.

Step 1. Seed 40 L (10 gal) of reagent-grade water with 1000 *Giardia* cysts and 2000 *Cryptosporidium* oocysts. Pass the spiked water through a 1 µm nominal porosity cartridge filter using the procedures found in **Part 9 - Sampling** of **Section VII**.

Step 2. Process the filtered water using the FILTER ELUTION AND CONCENTRATION, FLOTATION PURIFICATION and INDIRECT FLUORESCENT ANTIBODY procedures in **Part 10** of **Section VII**.

Step 3. Examine the entire concentrate for *Giardia* cysts and *Cryptosporidium* oocysts using the **Microscopic Examination** procedure of **Part 10** of **Section VII**. It is not necessary to identify internal morphological characteristic using differential interference contrast microscopy. If cysts and oocysts are not detected, do not process any more unknown samples until the reason(s) for not recovering cysts and oocysts is determined and corrected.

B. Viral Quality Control Samples:

1. Negative QC Viral Sample Preparation: This control is a check on equipment, materials, reagents and technique. It involves processing a 1MDS filter and examining that sample as if it were an unknown using the indicated procedures from the **Virus Monitoring Protocol for the ICR** (see **Section VIII**).

Step 1. Place a sterile 1MDS filter into a standard filter apparatus.

Step 2. Process and analyze the 1MDS filter using the procedures in **Part 2 — Sample Processing** and **Part 3 — Total Culturable Virus Assay** of **Section VIII**. If any virus is detected, do not process any more unknown samples until the source(s) of the contamination is located and corrected.

2. Positive QC Viral Sample Preparation: The purpose of this control is to assure that the laboratory can recover virus with the indicated procedures from the **Virus Monitoring Protocol for the ICR** (see **Section VIII**) when virus is spiked into a sample at a known level.

Step 1. Place 40.0 L of reagent grade water into a sterile polypropylene container.

Step 2. Thaw the low-titered virus QC sample containing 1 mL with 200 PFU of virus. Add the entire contents of the vial into the reagent grade water and rinse the vial with 1 mL of the water. Mix and pump the solution through a standard apparatus containing a 1MDS filter using the procedures in **Part 1 — Sample Collection Procedure** of **Section VIII**.

Step 3. Process and analyze the 1MDS filters containing QC stock virus using the procedures in **Part 2 — Sample Processing** and **Part 3 — Total Culturable Virus Assay** of **Section VIII**. If virus is not detected, do not process any more unknown samples until the reason(s) for not recovering virus is determined and corrected.

3. Coliphage Assay: Quality Control Samples have not been developed for the coliphage assay. Each laboratory should plan and conduct its own internal QC checks.

C. Quality Control Batch:

All protozoan and virus samples processed by an analyst within one week's span shall be considered to be a "**batch**". A week is defined as a Sunday to Saturday time frame. Each sample result must be associated with a batch number. An appropriate positive and negative QC sample set must be processed with each batch. In the case of the protozoan analysis, the QC sample set should be processed at the beginning of the week's batch, if possible.

1. Failure to obtain both a positive value in the positive QC sample and a negative value in the negative QC sample results in failure of the whole batch. Consequently, data from that batch would be excluded from the ICR database.
2. Obtaining a positive value in the positive QC sample and a negative value in the negative QC sample results in acceptance of the data from the whole batch. Data must be reported for all of the samples in that batch.

D. Flagging of Sample Data not Meeting Other Quality Control Conditions:

Other quality control conditions are described in the protozoan and virus protocols. Failure to comply with these conditions may decrease the pathogen concentrations, giving false negative results or measured values that are lower than the actual levels in water samples. If such a sample cannot be collected again within the time requirements of the final ICR rule, it should be analyzed. The associated data should be flagged, and the reason for the flag placed in the comment field of the database. The following flag conditions have been identified:

1. Thiosulfate not added to finished waters with disinfectant.
2. pH not reduced to below 8.0 for virus samples.
3. Collected sample volume outside the recommended range.
4. Partial or complete freezing of sample.
5. Sample shipped without ice or chemical ice.
6. Sample arrived at ambient temperature (insufficiently cooled -- not cold to touch).
7. Maximum shipping holding time exceeded.
8. Maximum sample process or analysis time requirements exceeded.
9. Cytotoxicity in virus assays.

Samples that do not conform to other lab- or utility-specified QA conditions should be treated according to the appropriate QA plans.

EPA will convert flagged data from "**quantitative**" to "**qualitative**" by changing all positive values to "PD." All less than detection limit values will be changed to "ND." PD indicates that pathogens were detected under conditions where pathogen levels are likely to be higher than the value actually measured. ND indicates that pathogens were not detected either



due to their absence from samples or due to conditions that result in obtaining values that are less than the detection limit.

Several conditions, including the lack of a temporal relationship between finished and raw water samples and the possible addition of high pathogen numbers through recycling of filter backwash water, create the possibility of observing higher pathogen levels in finished water than in raw water. Due to this possibility, water systems must not flag such data, unless the conditions listed above apply.

## INTRALABORATORY QC PROCEDURES

The following minimal quality control procedures should be followed for laboratory equipment, reagents and supplies. See **Section V** and **Appendix C** and **D** for detailed procedures as they relate to the protozoa and virus methods.

### **pH meter:**

Standardize the pH meter prior to each use with pH 7.00 and pH 4.00 standard buffers for solutions with pH values less than 7.0 and pH 7.00 and pH 10.00 standard buffers for solutions with pH values greater than 7.0.

Date standard buffer solutions upon receipt and when opened. Discard before expiration date.

### **Balance (top loader or pan):**

Calibrate balance monthly using Class S or S-1 reference weights (minimum of three traceable weights which bracket laboratory weighing needs) or weights traceable to Class S or S-1 weights. Calibrate non-reference weights annually with Class S or S-1 reference weights.

Maintain service contract or internal maintenance protocol and maintenance records. Conduct maintenance annually at a minimum.

### **Temperature Monitoring Device:**

Check calibration of each in-use glass/mercury thermometer annually and of each in-use dial thermometer quarterly, at the temperature used, against a reference National Institute of Standards and Technology (NIST) thermometer or one that meets the requirements of NIST Monograph SP250-23.

Recalibrate continuous recording devices annually which are used to monitor incubator temperature using the NIST reference thermometer described above.

**Incubator Unit:**

Record temperature once per day for each workday in use.

**Autoclave:**

Record date, contents, sterilization time, and temperature for each cycle. Establish a service contract or internal maintenance protocol, and maintain records.

Use maximum-temperature registering thermometer, heat sensitive tape, or spore strips or ampules during each autoclave cycle and record temperature. Avoid overcrowding.

Check automatic timing mechanism with stopwatch quarterly.

**Hot Air Oven:**

Record date, contents, and sterilization time and temperature of each cycle.

**Conductivity Meter:**

Calibrate conductivity meter monthly with a 0.01 M KCl solution, or lower concentration if desired (see Method 120.1 in EPA, 1979 or Section 2510, "**Conductivity**" p 2-43, in APHA, 1995). An in-line conductivity meter does not need to be calibrated.

**Refrigerator:**

Record temperature at least once per day for each workday in use.

**Ultraviolet Lamp (if used):**

Test lamp quarterly with UV light meter and replace if it emits less than 70% of initial output or if agar spread plates containing 200 to 250 microorganisms, exposed to the UV light for two minutes, do not show a count reduction of 99%. Other methods may be used to test a lamp if they are as effective as the two suggested methods.

**Glassware Washing:**

Perform the Inhibitory Residue Test (APHA, 1995) on the initial use of a washing compound and whenever a different formulation of washing compound or washing procedure is used to ensure that glassware is free of toxic residues. Laboratories purchasing large quantities of washing compound may avoid assay problems by testing the compound on an annual basis.

### Reagent Grade Water:

Test the quality of the reagent grade water or have it tested by a certified laboratory to assure it meets the criteria in **Table IV-1**.

<b>TABLE IV-1. REAGENT GRADE WATER PURITY PARAMETERS</b>		
<b>Parameter</b>	<b>Limits</b>	<b>Frequency</b>
Conductivity	>0.5 megohms-cm resistance or <2 µmhos/cm at 25°C	Monthly
Pb, Cd, Cr, Cu, Ni, Zn	Not greater than 0.05 mg/L per containment. Collectively, no greater than 0.1 mg/L	Annually
Total Chlorine Residual <sup>1</sup>	Nondetectable	Monthly
Heterotrophic Plate Count <sup>2</sup>	<500/mL	Monthly
Bacteriological Quality of Reagent Water <sup>3</sup>	Ratio of growth rate of 0.8-3.0	Annually
<sup>1</sup> DPD method not required if source water is not chlorinated. <sup>2</sup> Pour plate method. <sup>3</sup> Test for bacteriological quality of reagent water (APHA, 1995; or Bordner and Winter, 1978). Control water for the test is defined as double distilled water using a glass unit.		

### INTERLABORATORY QC PROCEDURES

EPA has decided to use Performance Evaluation (PE) studies as EPA's check on inter-laboratory performance. PE samples will be distributed to the ICR laboratories on a monthly basis. See **Performance Evaluation Samples** in **Section III**.

### RECORDING AND REPORTING QC DATA

Records of sample information, microbiological analyses, and method and intralaboratory QC test data are information that must be recorded and stored. Typically, the laboratory must forward sample analytical reports to the treatment plant and retain copies for its own records. Records of sample information, microbiological analyses, and method and intralaboratory QC must be kept by the laboratory for at least five years. Microbiological analysis records and methods QC data includes all raw data with calculations.

## LITERATURE CITED

APHA. 1995. Standard Methods for the Examination of Water and Wastewater, 19th Ed., American Public Health Association, Washington, D.C., pp. 9-4 to 9-6.

Bordner, B. and J. Winter. 1978. Microbiological Methods for Monitoring the Environment. U.S. Environmental Protection Agency Publication No. EPA-600/8-78-017, Cincinnati, OH, pp. 200-203.

EPA. 1979. Methods of chemical analyses of water and wastes. U.S. Environmental Protection Agency Publication No. EPA/600/4-79-020, (revised 1983), Cincinnati, OH.

## SECTION V. ON-SITE LABORATORY EVALUATION

### GENERAL EVALUATION CRITERIA

#### **ICR Laboratory Consultant:**

On-site laboratory evaluations will be conducted by an ICR Laboratory Consultant, who will be a U.S. EPA employee or a contracted environmental microbiologist. The ICR Laboratory Consultant will record laboratory information during the site visit according to the evaluation criteria listed below. U.S. EPA will use the recorded information to make all decisions about laboratory approval. Contracted ICR Laboratory Consultants will not participate in approval decisions.

#### **Evaluation Scheduling:**

A U.S. EPA person or contractor designated to schedule on-site evaluations will contact the Director of the Laboratory to set a mutually agreeable date and time for the visit. The evaluation will be scheduled at a time, if possible, that will result in minimal disruption of laboratory activities; however, all personnel who will be analyzing ICR samples must be available to perform the protozoan and/or viral tests for which approval is requested. As a guide, a minimum of three days will be scheduled.

Before the on-site evaluation, the ICR Laboratory Consultant will review the information submitted on the application and, if completed, the performance of each analyst on QC and PE samples. If the laboratory has been previously evaluated in the drinking water program, the ICR Laboratory Consultant will review that report to ensure that any applicable deviations, problems, suggested changes, or improvements have been addressed and corrected.

At the start of the on-site evaluation, the ICR Laboratory Consultant will meet the Laboratory Director and all members who will perform the test procedures to discuss the general aspects of the laboratory evaluation.

The ICR Laboratory Consultant will use a checklist as a guide to ask questions and to record evaluation results. The **Checklist for Laboratory Approval for *Giardia* and *Cryptosporidium*** is given in **Appendix C**. The **Checklist for Laboratory Approval for Total Culturable Viruses** is given in **Appendix D**. The use of a checklist provides a logical sequence to ensure that all critical elements and recommended items related to the technical procedures, equipment items, chemical reagents, media requirements, and associated activities are covered. The Consultant will likely ask additional questions to ascertain the experience and knowledge of the laboratory personnel in all these areas.

Records of all method and intralaboratory QC and bench sheets must be available for inspection. Any deficiencies noted in records or bench sheets will be included in a written report.

Each person who must be individually approved (see **Section III**) will be required to demonstrate their ability to perform the analytical protozoan or virus protocol during the evaluation. The ICR Laboratory Consultant will also evaluate the ability of other personnel to perform those protocol steps for which they will be responsible during the monitoring period of the ICR. The laboratory must have sufficient reagents and materials available so that all personnel requesting analytical approval can conduct the required assays.

The ICR Laboratory Consultant may meet with the Laboratory Director and laboratory staff at the end of the on-site visit to present comments and recommendations on methodology, instrumentation, sampling, sample holding times, quality assurance, or other subjects.

A formal written report of the evaluation will be forwarded to the Laboratory Director no later than 30 days after the evaluation.

Since the ICR microanalytical program is scheduled for 18 months, only one on-site evaluation of each laboratory will be conducted.

## SECTION VI. LABORATORY APPROVAL STATUS

The U.S. EPA Laboratory Approval Program is a limited coverage program established to carry out the provisions of the ICR.

### APPROVAL CLASSIFICATION

Laboratories, principal analysts and analysts will be classified according to the following:

#### **Laboratories:**

- Approved** - the laboratory meets the requirements for physical facilities and equipment.
- Not Approved** - the laboratory possesses major facilities or equipment deficiencies, or does not have an approved analyst.

Only laboratories with an “**Approved**” status are qualified to analyze ICR samples. It is the water system’s responsibility to ensure that only an “**Approved**” analytical laboratory is used. If the U.S. EPA notifies a system that its contracted analytical laboratory’s status has been changed from “**Approved**” to “**Not Approved**,” the system must take immediate steps to find another approved laboratory.

#### **Principal Analysts/Analysts<sup>3</sup>:**

- Approved** - The analyst (1) demonstrates strict adherence to the ICR analytical methods during an on-site evaluation, (2) performs satisfactorily on QC samples and (3) successfully analyzes unknown PE samples.
- Conditionally Approved** - The analyst does not perform satisfactorily on unknown PE samples during any six month period and has not completed analysis of the next scheduled monthly sample.
- Not Approved** - The analyst does not demonstrate method proficiency during an on-site evaluation, does not perform satisfactorily on QC samples or does not successfully analyze unknown PE samples.

---

<sup>3</sup>These approval categories apply to principal analysts and analysts from laboratories performing virus analyses and to principal analysts from laboratories performing protozoan analyses.

Approval of principal analysts and analysts for the ICR is laboratory-dependent. All analysts who transfer to another laboratory lose their approval status and are not eligible to immediately perform ICR analyses at a new laboratory. The following steps must be performed before the analyst is eligible to analyze ICR samples: 1) an amended **ICR Application for Approval** (see **Appendix B**) listing the qualifications of the analyst must be submitted by the new laboratory and accepted by EPA, and 2) principal analysts and analysts (virus laboratories only) must successfully analyze an unknown PE sample set at the new facility.

#### CRITERIA FOR CHANGING APPROVAL STATUS

The approval status of a laboratory or analyst may be changed during the ICR according to the following criteria:

##### **Changing Laboratory Approval Status:**

It is the responsibility of analytical laboratories to notify U.S. EPA within seven days of any change (e.g., personnel, equipment, laboratory facilities, location, etc) in ICR application status. Failure to notify U.S. EPA of changes may result in loss of approval. If U.S. EPA decides that a laboratory is subject to downgrading to a "**Not Approved**" status because of the change, the Laboratory Director or owner will be notified in writing (**by registered or certified mail**) of the proposed change of classification. The Laboratory Director or owner will have seven days from the date of the notification to review the deficiency cited and respond to the U.S. EPA in writing specifying what corrective actions are being taken. The U.S. EPA will consider the adequacy of the response and notify the laboratory by mail within seven days of its approval status.

##### **Changing Analyst Approval Status:**

The approval status of analysts using the ICR analytical methods for protozoa or total culturable viruses will be changed based upon their performance on QC and PE samples (see **Figure VI-1**).

1. PE Samples: **Figure VI-2** gives the decision tree for deciding analyst approval status based upon PE sample data.
  - a. An approved analyst will fail a PE sample set by submitting PE sample data that fall outside the acceptable quantitative range for the PE lots analyzed or by submitting late PE sample data. Data will be considered late if the data are not mailed to the U.S. EPA within two weeks of the shipping date of the sample to the analytical laboratory for protozoan analyzes and seven weeks for viral analyses.



## FIGURE VI-1. ICR - MICROBIOLOGY DECISION TREE

There are two criteria for on-going evaluation of Approved Analysts:

- Successful Analysis of PE Samples and Timely Submission of Data (Criterion #1)
- Successful Analysis of QC Samples and Timely Submission of Data (Criterion #2)

Criterion #1 is monitored and evaluated via a contractor in Cincinnati, Ohio, using the process outlined in **Figure VI-2**. Criterion #2 is monitored and evaluated via a contractor associated with the main ICR public database (Data Central), using the process outlined in **Figure VI-3**. The recommendations of the contractors are forwarded to U.S. EPA personnel in Cincinnati for review and action.

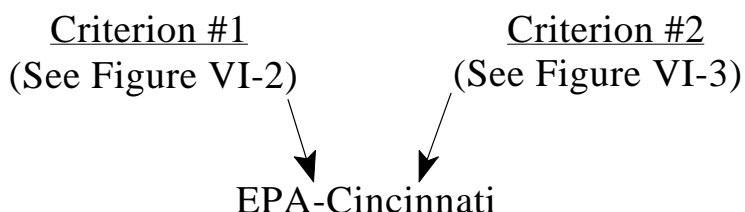

If U.S. EPA concurs with the recommendation to disapprove an analyst, the following actions will occur:

- The laboratory and the analyst will be notified of the loss of approval status for the method.
- Affected utilities will be notified.

b. Failure of an approved analyst to pass any six month set of PE samples will result in the analyst's status being changed to "**Conditionally Approved**". The data produced by that analyst following the failure will be flagged as questionable. If the analyst passes the next PE sample set, the analyst's status will be converted to "**Approved**", and his or her results will be accepted for ICR use.

c. If the analyst fails the next PE sample set, that analyst's status is immediately changed to "**Not Approved**." All the ICR sample data reported by that analyst from the date of analysis of the first failed PE sample to the date of the second failed PE sample will be converted from "**quantitative**" to "**qualitative**" by changing all positive values to "**PD**" and all less than detection limit values to "**ND**". PD indicates that pathogens were detected under conditions where pathogen levels are likely to be higher than the

**FIGURE VI-2. CRITERION #1 DECISION TREE**

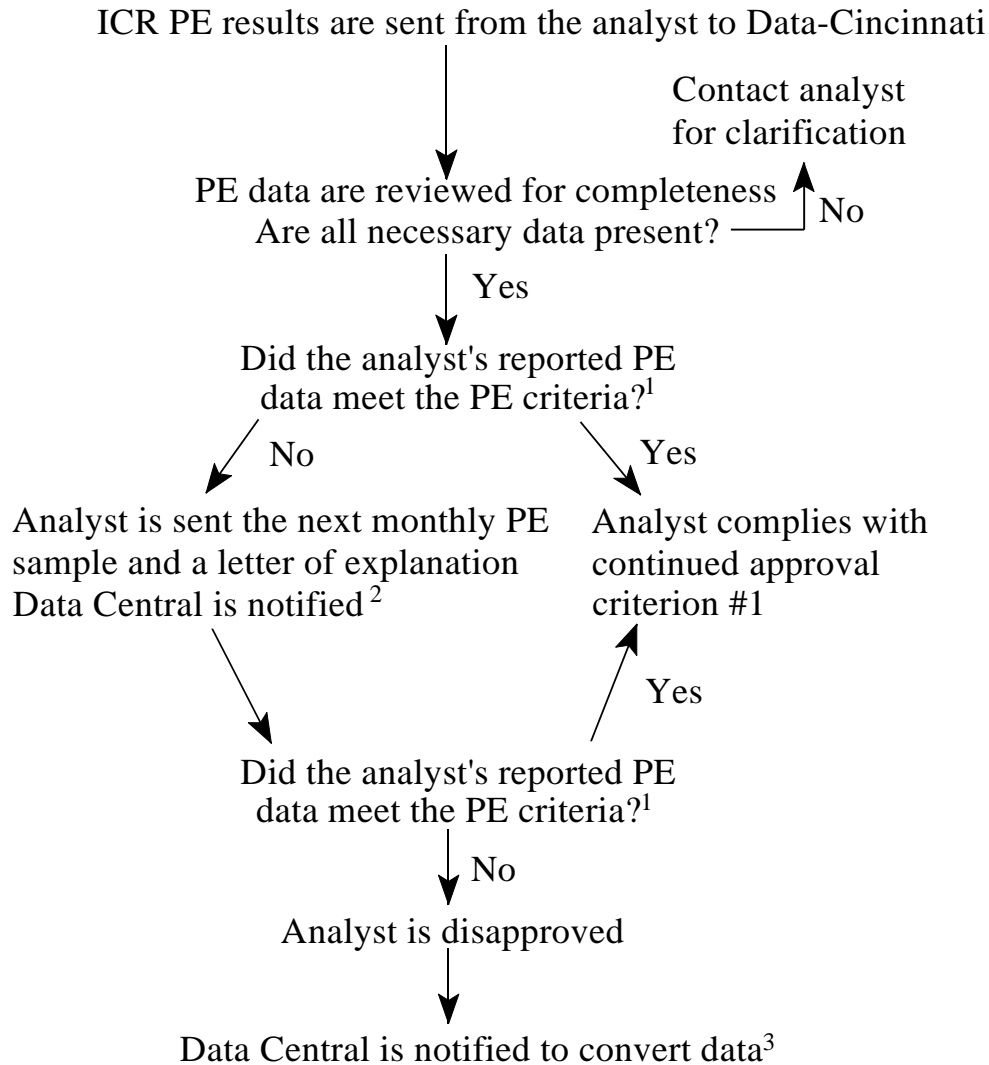

<sup>1</sup>Analysts do not meet PE criteria when their PE data fall outside the acceptable quantitative range for any PE sample set analyzed or if they do not report PE data to Data-Cincinnati within seven weeks for virus data and two weeks for protozoan data.

<sup>2</sup>Data Central will flag all data produced by an analyst since the ending date of the failed PE sample set as questionable and will convert the approval status of the analyst to "**Conditionally Approved.**"

<sup>3</sup>Data Central will convert data received from the ending date of the 1st PE sample set to the ending date of the 2nd PE sample set from "quantitative" to "qualitative" by changing all positive values to "PD" and all less than detection limits to "NP." All data received after the ending date of the 2nd PE sample set will be deleted. The approval status of the analyst will be converted to "**Not Approved.**"

value actually measured. ND indicates that pathogens were not detected either due to their absence from samples or due to conditions that result in obtaining values that are less than the detection limit. All data received after the date of analysis of the second PE sample set will be deleted.

2. QC Samples: **Figure VI-3** gives the decision tree for deciding analyst approval status based upon QC sample data.
  - a. The status of an approved analyst will be changed to “**Not Approved**” if the analyst obtains invalid QC data or submits late sample or QC data for **three consecutive** batches during any sliding six month period. QC data will be considered invalid if a positive value is obtained from the negative QC sample or if the observed values obtained from positive QC samples do not fall within an acceptable range. The acceptable range will be determined by the U.S. EPA. Protozoan QC data will be considered late if results are not submitted on the first monthly QC data disk that is due two weeks after the latest sample collection date within a batch. Virus QC data will be considered late if results are not submitted on the first monthly QC data disk that is due seven weeks after the latest sample collection date within a batch. Sample data will be considered late if U.S. EPA does not receive data by the time specified in the final rule.
  - b. The status of an approved analyst will be changed to “**Not Approved**” if the analyst obtains invalid QC data or submits late sample or QC data for **any two** batches during any sliding six month period for an analyst analyzing a batch every three to four weeks, from **any three** batches for an analyst analyzing a batch every two weeks, or from **any six** batches for an analyst analyzing a batch every week.
  - c. Data received from the date of analysis of the first failed QC sample set to the date of analysis of the QC sample set leading to disapproval will be converted from “**quantitative**” to “**qualitative**” by changing all positive values to “**PD**” and all less than detection limit values to “**ND**” as above. All data received after the date of analysis of the QC sample set leading to disapproval will be deleted. The approval status of the analyst will be converted to “**Not Approved**”.

#### SYSTEM FOR NOTIFYING UTILITIES OF LABORATORY STATUS

EPA will maintain and make available a list of “**Approved**” laboratories. The list will be distributed directly to participating water systems, as well as each U.S. EPA Regional Office and State Primacy Agency. The list will also be available for public distribution from the U.S. EPA.

**FIGURE VI-3. CRITERION #2 DECISION TREE**

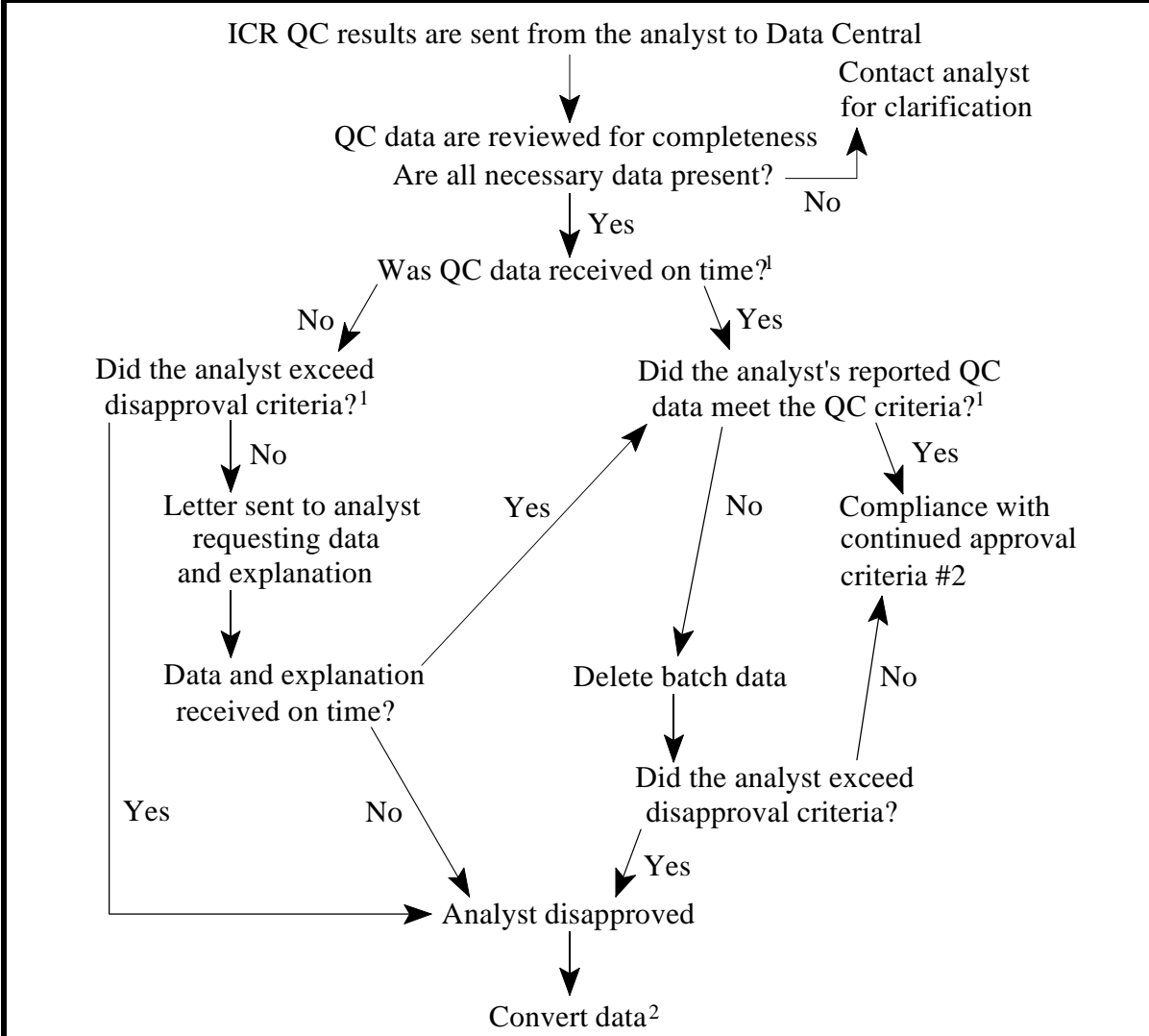

<sup>1</sup>Analysts will be disapproved for any of the following conditions: invalid QC data or late submission of data for three consecutive batches during sliding six month periods; invalid QC data or late submission of data from any two batches during sliding six month periods for analysts analyzing a batch every three to four weeks, from any three batches for analysts analyzing a batch every two weeks or from any six batches for analysts analyzing a batch every week.

<sup>2</sup>Data Central will convert data received from the date of analysis of the 1st failed QC sample to the date of analysis of the QC sample leading to disapproval from "quantitative" to "qualitative" by changing all positive values to "PD" and all less than detection limits to "NP." All data received after the date of analysis of the QC sample leading to disapproval will be deleted. The approval status of the analyst will be converted to "Not Approved."

**SECTION VII. ICR PROTOZOAN METHOD FOR DETECTING  
GIARDIA CYSTS AND CRYPTOSPORIDIUM OOCYSTS IN WATER  
BY A FLUORESCENT ANTIBODY PROCEDURE**

TABLE OF CONTENTS

PART 1 - SCOPE .....	VII-4
PART 2 - TERMINOLOGY .....	VII-4
PART 3 - SUMMARY OF TEST METHOD .....	VII-5
PART 4 - SIGNIFICANCE AND USE .....	VII-5
PART 5 - INTERFERENCES .....	VII-5
PART 6 - APPARATUS .....	VII-6
SAMPLE COLLECTION .....	VII-6
SAMPLE PROCESSING .....	VII-7
SAMPLE EXAMINATION .....	VII-8
PART 7 - REAGENTS .....	VII-8
REAGENT PURITY .....	VII-8
REAGENT PREPARATION .....	VII-9
Sample Collection .....	VII-9
Sample Processing .....	VII-9
Sample Examination .....	VII-10
PART 8 - PRECAUTIONS .....	VII-11
PART 9 - SAMPLING .....	VII-11
SAMPLING APPARATUS PREPARATION AND ASSEMBLY .....	VII-11
RAW WATER SAMPLE COLLECTION .....	VII-12
FINISHED WATER SAMPLE COLLECTION .....	VII-16
PART 10 - ASSAY PROCEDURE .....	VII-17
FILTER ELUTION AND CONCENTRATION .....	VII-17
Washing By Hand .....	VII-17
Stomacher Washing .....	VII-18
Eluate Concentration .....	VII-18
FLOTATION PURIFICATION .....	VII-19
INDIRECT FLUORESCENT ANTIBODY (IFA) PROCEDURE .....	VII-19
Determining Sample Volume per Filter (optional) .....	VII-19

Preparing the Filtration Manifold .....	VII-20
Membrane Filter Preparation .....	VII-20
Sample Application .....	VII-22
Indirect Fluorescent Antibody Staining .....	VII-24
Filter Mounting .....	VII-24
Microscopic Examination .....	VII-25
General .....	VII-25
IFA Controls .....	VII-26
Negative IFA Control for <i>Giardia/Cryptosporidium</i> .....	VII-26
Positive IFA Control for <i>Giardia/Cryptosporidium</i> .....	VII-26
Sample Examination .....	VII-27
Calculation .....	VII-28
Reporting .....	VII-31
Quality Control (QC) Samples .....	VII-31
Negative QC Sample Preparation .....	VII-31
Positive QC Sample Preparation .....	VII-31
PART 11 - EDUCATION, TRAINING AND PROFICIENCY .....	VII-32
MINIMAL PERSONNEL REQUIREMENTS .....	VII-32
Principal Analyst/Supervisor: .....	VII-32
Analyst .....	VII-32
Technician .....	VII-33
PART 12 - KEY WORDS .....	VII-33
Appendix VII-1. CLEANING THE MANIFOLD AND WELLS .....	VII-34
MANIFOLD .....	VII-34
STAINLESS STEEL WELLS .....	VII-34
Appendix VII-2. SAMPLE CALCULATION .....	VII-35
POSITIVE SAMPLES .....	VII-35
NEGATIVE SAMPLES .....	VII-36
Appendix VII-3. <i>GIARDIA</i> REPORT FORM .....	VII-37
Appendix VII-4. <i>CRYPTOSPORIDIUM</i> REPORT FORM .....	VII-38
Appendix VII-5. MICROSCOPE ADJUSTMENTS .....	VII-39
EPIFLUORESCENT MERCURY BULB AND TRANSMITTED LIGHT BULB FILAMENT .....	VII-39
Mercury Bulb Adjustment .....	VII-39
Transmitted Bulb Adjustment .....	VII-40
ADJUSTMENT OF INTERPUPILLARY DISTANCE AND OCULARS .....	VII-40

Interpupillary Distance .....	VII-40
Ocular Adjustment for Each Eye. ....	VII-41
For microscopes not capable of photomicrography .....	VII-41
For microscopes capable of viewing a photographic frame .....	VII-41
CALIBRATION OF AN OCULAR MICROMETER .....	VII-41
KÖHLER ILLUMINATION .....	VII-43

## PART 1 - SCOPE

1. This test method describes the detection and enumeration of *Giardia* cysts and *Cryptosporidium* oocysts in ground, surface, and finished waters by a fluorescent antibody procedure. These pathogenic intestinal protozoa occur in domestic and wild animals as well as in humans. The environment may become contaminated through direct deposit of human and animal feces or through sewage and wastewater discharges to receiving waters. Ingestion of water containing these organisms may cause disease.
2. Results obtained by this method should be interpreted with extreme caution. High and low turbidity can affect the recovery efficiency of this method. Failure to detect organisms of interest and/or a low detection limit does not ensure pathogen-free water.
3. This method does not purport to address all of the safety problems associated with its use. It is the responsibility of the user of this method to establish appropriate safety and health practices and determine the applicability of regulatory limitations prior to use.

## PART 2 - TERMINOLOGY

### DESCRIPTION OF TERMS SPECIFIC TO THIS METHOD

1. axoneme - an internal flagellar structure which occurs in some protozoa, e.g., *Giardia*, *Spironucleus*, and *Trichomonas*.
2. cyst - a phase or a form of an organism produced either in response to environmental conditions or as a normal part of the life cycle of the organism. It is characterized by a thick and environmentally-resistant cell wall.
3. median bodies - prominent, dark-staining, paired organelles consisting of microtubules and found in the posterior half of *Giardia*. In *G. lamblia* (from humans), these structures often have a claw-hammer shape while in *G. muris* (from mice), the median bodies are round.
4. oocyst - the encysted zygote of some Sporozoa, e.g., *Cryptosporidium*. This is a phase or a form of the organism produced either in response to environmental conditions or as a normal part of the life cycle of the organism. It is characterized by a thick and environmentally-resistant cell wall.
5. sporozoite - a motile, infective, asexual stage of certain sporozoans, e.g., *Cryptosporidium*. There are four sporozoites in each *Cryptosporidium* oocyst, and they are generally banana-shaped.



6. Nucleus - a prominent internal structure seen both in *Giardia* cysts and *Cryptosporidium* oocysts. Sometimes one to four nuclei can be seen in *Giardia* cysts. In *Cryptosporidium* oocysts there is one nucleus per sporozoite.

### **PART 3 - SUMMARY OF TEST METHOD**

Pathogenic intestinal protozoa are concentrated from a large volume of water sample by retention on a yarn-wound filter. Retained particulates are eluted from the filter with an eluting solution and are concentrated by centrifugation. *Giardia* cysts and *Cryptosporidium* oocysts are separated to some extent from other particulate debris by flotation on a Percoll-sucrose solution with a specific gravity of 1.1. A monolayer of the water layer/Percoll-sucrose interface is placed on a membrane filter, indirectly stained with fluorescent antibody, and examined under a microscope. Cysts and oocysts are classified according to specific criteria (immunofluorescence, size, shape, and internal morphological characteristics), and the results are reported in terms of the categories per 100 L. The categories used in reporting include cysts and oocysts that are empty, that have amorphous structure, and that have internal structure. A sum of the cysts and oocysts that fall into each of these categories is also reported as the total IFA count.

### **PART 4 - SIGNIFICANCE AND USE**

1. This test method will provide a quantitative indication of the level of contamination in raw and treated drinking waters with the environmentally resistant stages of two genera of pathogenic intestinal protozoa: *Giardia* and *Cryptosporidium*.
2. This test method will not identify the species of protozoa, it will not identify the host species of origin, it cannot determine the viability status, nor can it determine the infectivity status of detected cysts and oocysts.
3. This test method may be useful in determining the source or sources of contamination of water supplies, the occurrence and distribution of protozoa in water supplies, and in evaluating the effectiveness of treatment practices.

### **PART 5 - INTERFERENCES**

1. Turbidity due to inorganic and organic debris and other organisms can interfere with the concentration, purification and examination of the sample for *Giardia* cysts and *Cryptosporidium* oocysts.

2. In addition to naturally-occurring debris, e.g., clays and algae, debris may be added to water during the treatment process, e.g., iron and alum coagulants and polymers.
3. Organisms and debris that autofluoresce or demonstrate non-specific fluorescence, e.g., algal and yeast cells and *Spironucleus (Hexamita)* sp.<sup>1</sup>, when examined by epifluorescent microscopy could interfere with the detection of cysts and oocysts and contribute to false positive values.
4. Chlorine compounds, and perhaps other chemicals used to disinfect or treat drinking water and wastewater, may interfere with the visualization of internal structures of *Giardia* cysts and *Cryptosporidium* oocysts.
5. Freezing filter samples, eluates or concentrates could interfere with the detection and/or identification of cysts and oocysts originally present in the sample.

## PART 6 - APPARATUS

### SAMPLE COLLECTION

The following sampling apparatus components are required:

1. Filter and filter holder: Either a 25.4 cm (10 in.) long 1  $\mu$ m nominal porosity, yarn-wound polypropylene cartridge Commercial honeycomb filter tube (M39R10A; Commercial Filters Parker Hannifin Corp., P.O. Box 1300, Lebanon, IN) with a Commercial LT-10 filter holder or a 25.4 cm (10 in.) long 1  $\mu$ m nominal porosity Filterite polypropylene cartridge (U1A10U; Filterite Corporation, Timonium, MD), with a Filterite LMO10U-<sup>3</sup>/<sub>4</sub> filter holder must be used.
2. Garden hose or PVC tubing and connectors.
3. Water meter
4. Fluid proportioner (or proportioning injector) for disinfected water.
5. Pressure regulator.
6. Pressure gauge(s).
7. Flow control valve, 4 L/min.

---

<sup>1</sup>Januschka, M.M., *et al.* 1988. A comparison of *Giardia microti* and *Spironucleus muris* cysts in the vole: an immunocytochemical, light, and electron microscopic study. *J. Parasitol.* **74**(3):452-458.

8. Pump, electric or gasoline powered, for sampling unpressurized water sources.
9. Plastic sample bags, double-track, zipper-lock or equivalent, approximately 15 in. (38 cm) × 15 in (38 cm).
10. Ice chest or cooler.
11. Cold packs or wet ice.
12. Latex gloves.

### SAMPLE PROCESSING

The following apparatus components are required for sample processing:

1. Pans or trays, stainless steel or glass trays, approx. 16.5 in. (41.91 cm) × 10 in. (25.4 cm) × 2 in. (5.08 cm) deep.
2. Knife/cutting tool, for cutting the polypropylene filter fibers off filter core.
3. Hydrometer, for liquids heavier than water (range: 1.000-1.225), for adjusting specific gravity of flotation solutions.
4. Centrifuge, with swinging bucket rotors having a capacity of 15 to 250 mL or larger per conical tube or bottle.
5. Mixer, vortexer.
6. Vacuum source.
7. Membrane filter holder, Hoefer manifold, model FH 225V<sup>2</sup>, 10 place holder for 25 mm diameter filters.
8. Slide warming tray, or incubator, 37°C ± 3°C.
9. pH meter.
10. Rubber policeman.

---

<sup>2</sup>Hoefer Scientific Instruments, 654 Minnesota Street, Box 77387, San Francisco, California 94107

11. Stomacher Lab Blender, model 3500 (BA 7022)<sup>3</sup> (optional). The stomacher must either be equipped with a door (Tekmar cat. # 10-0770-000) and clamp strip (Tekmar cat. # 10-0771-000) or have had the paddles adjusted so all the filter fibers can be extracted at one time without stalling the instrument.

### SAMPLE EXAMINATION

1. Slides, glass microscope, 1 in. (2.54 cm.) × 3 in. (7.62 cm) or 2 in. (5.08 cm.) × 3 in. (7.62 cm.).
2. Cover slips, 25 mm<sup>2</sup>, No. 1½.
3. Filters, Sartorius brand<sup>4</sup> cellulose acetate, 0.2 µm pore size, 25 mm diameter.
4. Support Filters, ethanol-compatible membrane, any pore size, 25 mm.
5. Fingernail polish, clear or clear fixative (Cat. # 60-4890; PGC Scientifics<sup>5</sup>).
6. Splinter forceps, fine tip.
7. Blunt-end filter forceps.
8. A microscope, capable of epifluorescence and differential interference contrast (D.I.C.) or Hoffman modulation® optics, with stage and ocular micrometers and 20X (N.A. = 0.4) to 100X (N.A. = 1.3) objectives is required for sample examination. Equip the microscope with appropriate excitation and band pass filters for examining fluorescein isothiocyanate-labeled specimens (exciter filter: 450-490 nm; dichroic beam-splitting mirror: 510 nm; barrier or suppression filter: 515-520 nm).

## **PART 7 - REAGENTS**

### REAGENT PURITY

1. Purity of Reagents - Reagent grade chemicals shall be used in all tests. Unless otherwise indicated, it is intended that all reagents shall conform to the specifications of the committee on Analytical Reagents of the American Chemical Society where such specifica-

---

<sup>3</sup>Tekmar Company, P.O. Box 371856, Cincinnati, Ohio 45222-1856

<sup>4</sup>Sartorius Corp., Filter Div., 30940 San Clemente, Hayward, CA 94544

<sup>5</sup>PGC Scientifics, P.O. Box 7277, Gaithersburg, Maryland 20898-7277

tions are available<sup>6</sup>.

2. Purity of Water - Use reagent grade deionized or double distilled water (see Table IV-1).

### REAGENT PREPARATION

Prepare reagents as specified by the formulations.

#### **Sample Collection:**

1. Sodium Thiosulfate Solution (2.0 %) - Dissolve 2.0 g of sodium thiosulfate ( $\text{Na}_2\text{S}_2\text{O}_3 \cdot 5\text{H}_2\text{O}$ ) in 50 mL water and then adjust to a final volume of 100 mL.

#### **Sample Processing:**

1. Neutral Buffered Formalin Solution (10 %) - Dissolve 0.762 g disodium hydrogen phosphate ( $\text{Na}_2\text{HPO}_4$ ), 0.019 g sodium dihydrogen phosphate ( $\text{NaH}_2\text{PO}_4$ ), and 100 mL formalin in water to a final volume of 1 L.
2. Phosphate Buffered Saline (PBS) - Prepare a 10X stock solution by dissolving 80 g sodium chloride ( $\text{NaCl}$ ), 2 g potassium dihydrogen phosphate ( $\text{KH}_2\text{PO}_4$ ), 29 g hydrated disodium hydrogen phosphate ( $\text{Na}_2\text{HPO}_4 \cdot 12\text{H}_2\text{O}$ ) and 2 g potassium chloride ( $\text{KCl}$ ) in water to a final volume of 1 L. The 10X solution is used to prepare 1X PBS by diluting one volume of the 10X solution with 9 volumes of water and adjust the pH with a pH meter to 7.4 with 0.1 N HCl or 0.1 N NaOH before use.
3. Sodium Dodecyl Sulfate Stock Solution (1%) - Prepare solution by dissolving 1.0 g of sodium dodecyl sulfate (SDS) in water to a final volume of 100 mL.
4. Tween 80 Stock Solution (1 %) - Mix 1.0 mL of polyoxyethylenesorbitan monooleate 80 (Tween 80) stock solution with 99 mL of water.
5. Eluting Solution (Buffered Detergent Solution) - Prepare solution by mixing 100 mL 1% SDS, 100 mL 1% Tween 80, 100 mL 10X PBS, and 0.1 mL Sigma Antifoam A (Cat. # A 5758) with 500 mL water. Adjust the pH to 7.4 using a pH meter. Adjust the final volume to 1 L with additional water. Use within one week of preparation. At least 3 L of eluting solution will be required for each filter elution.

---

<sup>6</sup>Reagent Chemicals, American Chemical Society Specifications, American Chemical Society, Washington, DC. For suggestions on the testing of reagents not listed by the American Chemical Society, see Annular Standards for Laboratory Chemicals, BDH, Poole, Dorset, U.K. and the United States Pharmacopeia.

6. Sucrose Solution (2.5 M) - Dissolve 85.58 g of sucrose in 40 mL prewarmed water, then adjust the final volume to 100 mL with water.
7. Percoll-Sucrose Flotation Solution, Sp. Gr. 1.10 - Mix 45 mL Percoll (sp. gr. 1.13; Sigma Cat. # P 1644), 45 mL water and 10 mL 2.5 M sucrose solution. Check the specific gravity with a hydrometer. The specific gravity should be between 1.09 and 1.10 (do not use if less than 1.09). Store at 4°C and use within a week. Allow to reach room temperature before use.

**Sample Examination:**

1. Ensys Hydrofluor-Combo kit<sup>7</sup> for detecting *Giardia* cysts and *Cryptosporidium* oocysts in water samples. The expiration date for the reagents is printed on the Hydrofluor-Combo kit label. Discard the kit once the expiration date is reached. Store the kit at 2-8°C and return it promptly to this temperature range after each use. The labeling reagent should be protected from exposure to light. Do not freeze any of the reagents in this kit. Diluted, unused working reagents should be discarded after 48 hours.
2. Ethanol (95%).
3. Glycerol.
4. Ethanol/Glycerol Series - Prepare a series of solutions according to **Table VII-1**.
5. DABCO-Glycerol Mounting Medium (2%) - Prewarm 95 mL glycerol using a magnetic stir bar on a heating stir plate. Add 2 g 1,4 diazabicyclo [2.2.2] octane (DABCO, Sigma Cat. # D-2522) to the warm glycerol with continuous stirring until it dissolves. (CAUTION: hygroscopic; causes burns; avoid inhalation, as well as skin and eye contact.) Adjust the final volume to 100 mL with additional glycerol. Store at room temperature and discard after 6 months.

<b>Table VII-1. Ethanol/Glycerol Series</b>				
95% Ethanol	Glycerol	Reagent Water	Final Volume	Final % Ethanol
10 mL	5 mL	80 mL	95 mL	10
20 mL	5 mL	70 mL	95 mL	20
40 mL	5 mL	50 mL	95 mL	40
80 mL	5 mL	10 mL	95 mL	80
95 mL	5 mL	0 mL	100 mL	90.2

6. Bovine Serum Albumin (1%) - Sprinkle 1.0 g bovine serum albumin (BSA) crystals over 85 mL 1X PBS, pH 7.4. Allow crystals to fall before stirring into solution with a magnetic stir bar. After the BSA is dissolved, adjust the volume to 100 mL with

---

<sup>7</sup>Ensys Environmental Products, Inc., P.O. Box 14063, Research Triangle Park, North Carolina 27709

PBS. For prolonged storage, sterilize by filtering through a 0.22  $\mu\text{m}$  membrane filter into a sterile tube or bottle. Store at 4°C and discard after 6 months.

## **PART 8 - PRECAUTIONS**

1. The analyst/technician must know and observe the normal safety procedures required in a microbiology laboratory while preparing, using and disposing of sample concentrates, reagents and materials and while operating sterilization equipment.
2. Do not mouth pipet in any portion of this procedure.

## **PART 9 - SAMPLING**

### SAMPLING APPARATUS PREPARATION AND ASSEMBLY

1. The sampling apparatus (see **Figure VII-1**) used for raw water consists of a female hose connector, an inlet hose, pressure regulator, pressure gauge, filter holder, a 1  $\mu\text{m}$  nominal porosity filter, an outlet hose, a water meter, and a 1 gal/min flow control valve or device (4 L/min). The sampling apparatus for chlorinated or other disinfectant treated waters also includes a fluid proportioner or proportioning injector and pressure gauge on the influent side of the filter housing (see **Figure VII-2**). In addition, a pump will be needed for unpressurized sources.
2. Filter Holder
  - a. Thoroughly wash the filter holder with a stiff brush in hot water containing detergent, when sampling is completed.
  - b. Rinse the filter holder with tap water until the soap residue is gone. Follow with a thorough rinse in reagent water and air dry.

3. Attach a water-resistant label containing the following information to the filter holder:

Start \_\_\_\_\_ Meter Reading: \_\_\_\_\_ Turbidity: \_\_\_\_\_  
Stop Time: \_\_\_\_\_ Meter Reading: \_\_\_\_\_ Turbidity: \_\_\_\_\_  
Operator's Name: \_\_\_\_\_ Total Volume Filtered: \_\_\_\_\_  
Date: \_\_\_\_\_ Sampling \_\_\_\_\_

4. Hoses

a. Inlet and outlet hoses for the filter holder consist of standard garden hoses and fittings. If desired pressure, PVC tubing (½ inch I.D., ¾ inch O.D., ⅛ inch wall) and/or quick connects may be substituted for the standard garden hose and/or hose clamps.

b. Outlet hoses may be used repeatedly provided they are rinsed with at least 20 gal (76 L) of the water to be sampled prior to starting the sampling.

5. Pump: A pump is needed, when an unpressurized source is being sampled.

6. Fluid Proportioner or Proportioning Injector: If the water to be sampled is chlorinated or disinfected by any other chemicals, the disinfectant must be neutralized during sample collection. While the assay system allows detection of disinfected cysts and oocysts, exposure to disinfectant may interfere with the visualization of internal morphologies of these organisms. Use the sodium thiosulfate solution to neutralize the disinfectant in water samples. Add the sodium thiosulfate solution to the water during sample collection with a mechanical fluid proportioner pump or an in-line injector at a rate of 10 mL/gal of water sampled.<sup>8</sup>

### RAW WATER SAMPLE COLLECTION

Step 1. Put on a pair of the latex gloves.

Step 2. Before connecting the sampling apparatus (see **Figure VII-1**) to the tap or source to be sampled, turn on the tap and allow the water to purge residual debris from the line for 2-3 min, or until the turbidity of the water becomes uniform.

---

<sup>8</sup>Details on the operation and use of proportioner pumps and injectors can be found in: Virus concentration from large sample volumes by adsorption to and elution from microporous filters, Section 9510C, pp. 9-92 to 9-95. In A.E. Greenberg, L.S. Clesceri and A.D. Eaton, ed., Standard Methods for the Examination of Water and Wastewater. 19th ed., 1995. American Public Health Association, Washington, D.C. It is not necessary to determine that chlorine is absent from the effluent because thiosulfate is added in excess.



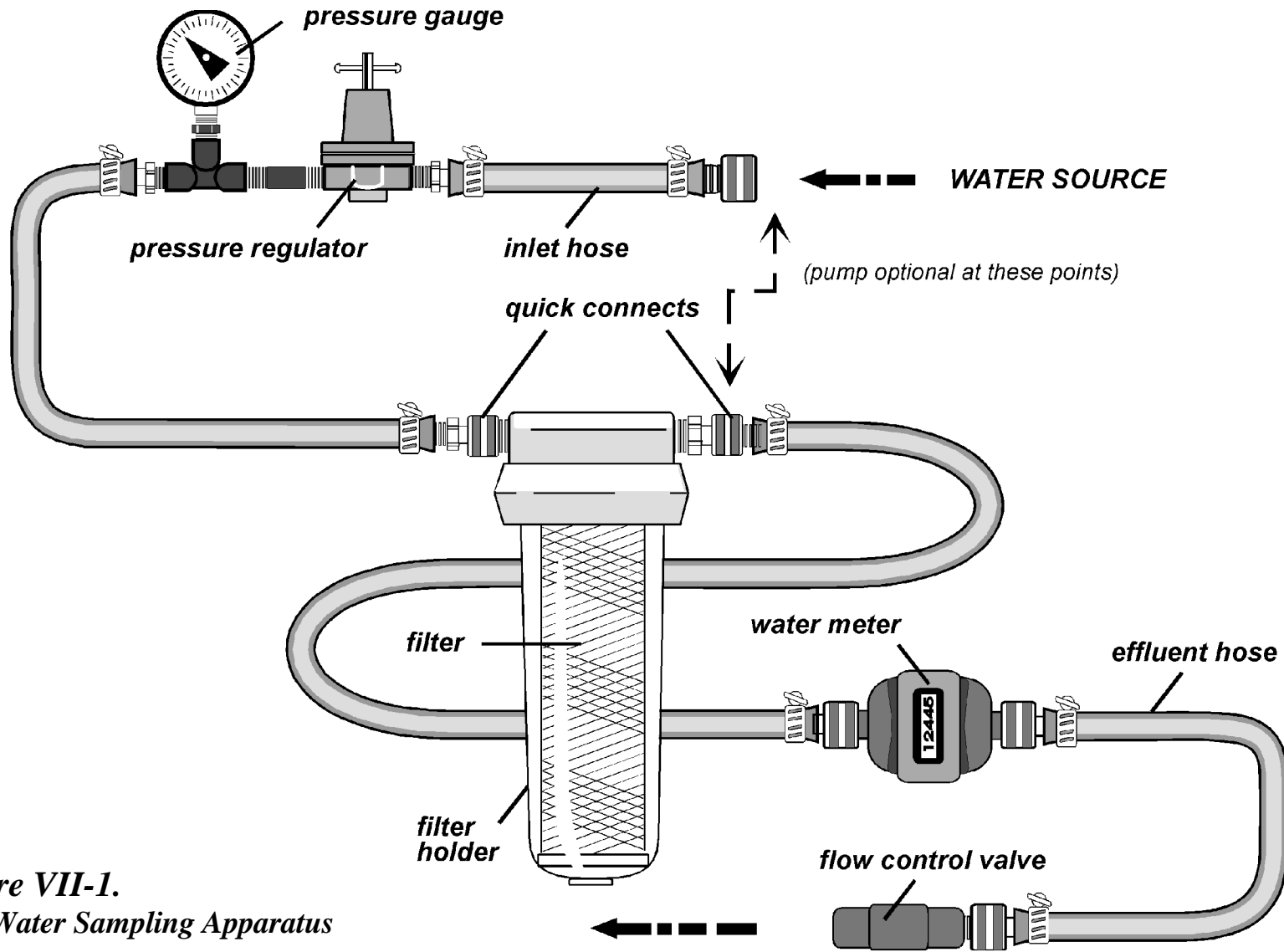

**Figure VII-1.**  
**Raw Water Sampling Apparatus**

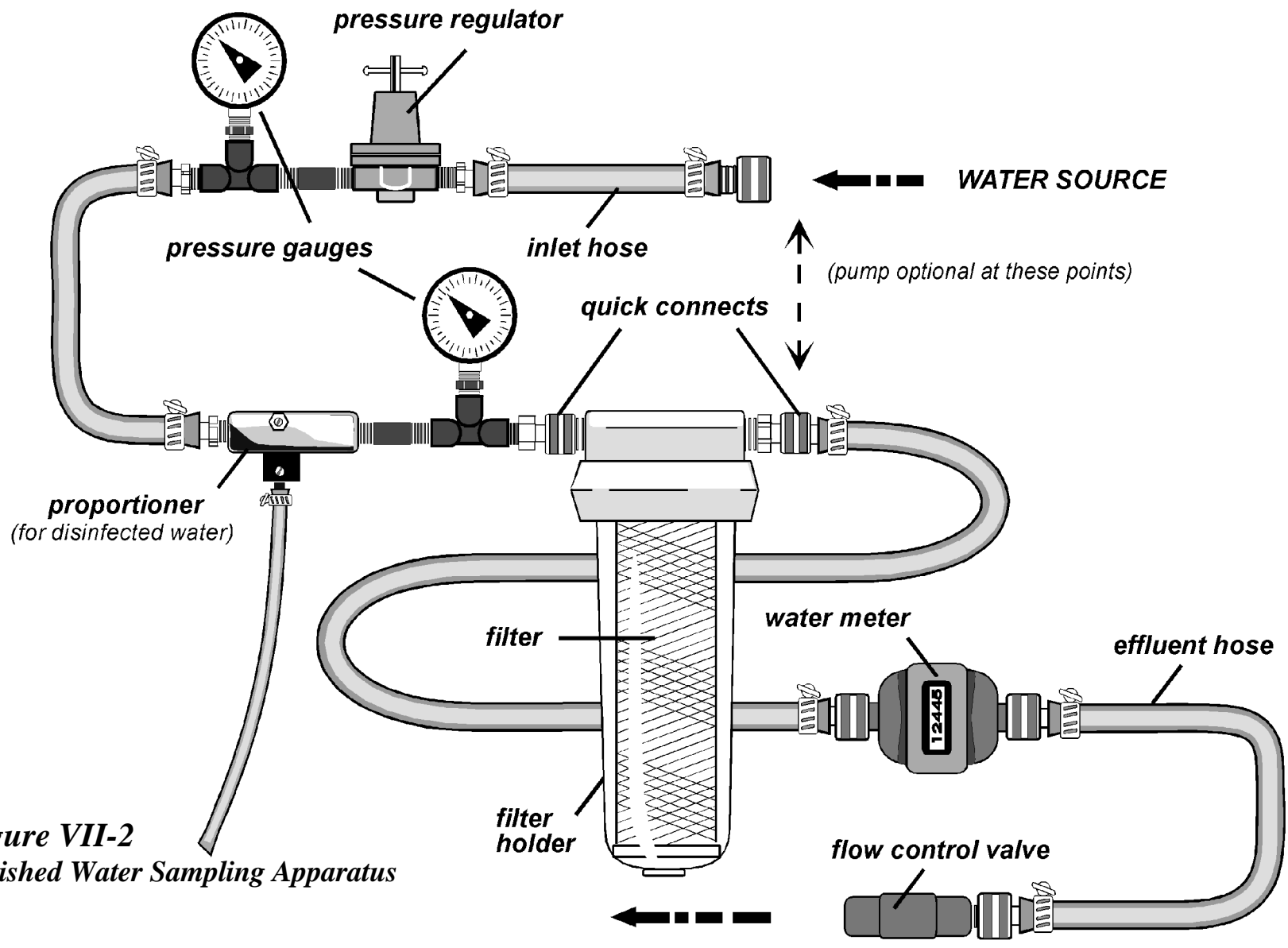

**Figure VII-2**  
**Finished Water Sampling Apparatus**

Step 3. Connect the apparatus minus the filter to the tap and allow 20 gal (76 L) to flush the system. If a pressurized source is not available, use a pump, following the manufacturer's instructions, to get water through the sampling apparatus. While the flushing of the apparatus is being done, adjust the pressure regulator so the adjacent pressure gauge reads no more than 30 pounds per square inch (PSI).

Step 4. Turn off the water flow, when the flushing of the apparatus is complete. Open the filter housing and pour all the water out. Put the filter in, close, and tighten the filter housing.

Step 5. Use a water-resistant marking pen to record the start time, meter reading, name of person collecting the sample, turbidity, date and sampling location on the filter holder label.

Step 6. Start water flow through the filter. Check the pressure gauge after the pressure regulator to make sure the reading is no more than 30 PSI. Readjust the regulator, if necessary.

Step 7. After the 100 L (26.4 gal) of raw water has passed through the filter, shut off the water flow, record the stop time, final meter reading and turbidity of the water at the end of filtration on the filter holder label.

Step 8. Disconnect the sampling apparatus while maintaining the inlet hose level above the level of the opening on the outlet hose to prevent backwashing and the loss of particulate matter from the filter.

Step 9. After allowing the apparatus to drain, open the filter housing and pour the residual water remaining in the filter holder into a plastic sample bag.

Step 10. Aseptically remove the filter from the holder and transfer the filter to the plastic sample bag containing the residual water. Seal the bag. Do not set the bag down or allow it to touch any environmental surface.

Step 11. Immediately place the bag inside a second plastic sample bag and then seal the second (outer) bag. Transfer the label or label information from the filter holder to the outside of this second (outer) bag.

Step 12. Transport the sample to the laboratory on wet ice or with, but not, on cold packs. When the filter(s) arrive at the laboratory, they should be immediately stored at 2-5°C. Do not freeze the filter during transport or storage.

## FINISHED WATER SAMPLE COLLECTION

If the water must be neutralized, add sodium thiosulfate solution via the proportioner system. For each 100 L of finished water sampled, 250 mL of 2.0% sodium thiosulfate solution will be needed.

Step 1. Put on a pair of the latex gloves.

Step 2. Before connecting the sampling apparatus (see **Figure VII-2**) to the tap or source to be sampled, turn on the tap and allow the water to purge residual debris from the line for 2-3 min, or until the turbidity of the water becomes uniform.

Step 3. Connect the apparatus minus the filter to the tap and allow 20 gal (76 L) to flush the system. If a pressurized source is not available, use a pump, following the manufacturer's instructions, to get water through the sampling apparatus. While the flushing is being done adjust the pressure regulator, so the adjacent pressure gauge reads no more than 30 PSI. Pour the 2% sodium thiosulfate solution into a graduated cylinder. Place the injector tube into the solution and adjust the larger top (vacuum) screw on the injector, so the pressure on the pressure gauge following the injector reads no more than 19 PSI. Now adjust the smaller bottom (flow) screw on the injector, so the flow rate of the thiosulfate solution is 10 mL/min. A hose cock clamp on the injector tube may be required to achieve the correct thiosulfate flow rate. After this adjustment is complete, transfer the injector tube to a graduated carboy of thiosulfate solution.

Step 4. Turn off the water flow, when the flushing of the apparatus is complete. Open the filter housing and pour all the water out. Put the filter in, close, and tighten the filter housing.

Step 5. Use a water-resistant marking pen to record the start time, meter reading, name of person collecting the sample, turbidity, date and sampling location on the filter holder label.

Step 6. Start water flow through the filter. Check the pressure gauge after the pressure regulator to make sure the reading is no more than 30 PSI. Also check to make sure the thiosulfate solution is being drawn into the sampling apparatus. Readjust the regulator and injector, if necessary.

Step 7. After the 1,000 L (264.2 gal) of finished water has passed through the filter, shut off the water flow, record the stop time, final meter reading and turbidity of the water at the end of filtration on the filter holder label.

Step 8. Disconnect the sampling apparatus while maintaining the inlet hose level above the level of the opening on the outlet hose to prevent backwashing and the loss of particulate matter from the filter.

Step 9. After allowing the apparatus to drain, open the filter housing and pour the residual water remaining in the filter holder into a plastic sample bag.

Step 10. Aseptically remove the filter from the holder and transfer the filter to the plastic sample bag containing the residual water. Seal the bag. Do not set the bag down or allow it to touch any environmental surface.

Step 11. Immediately place the bag inside a second plastic sample bag and then seal the second (outer) bag. Transfer the label or label information from the filter holder to the outside of this second (outer) bag.

Step 12. Transport the sample to the laboratory on wet ice or with but not on cold packs and refrigerate at 2-5°C. Do not freeze the filter during transport or storage.

## **PART 10 - ASSAY PROCEDURE**

### **FILTER ELUTION AND CONCENTRATION**

The initiation of sample collection and elution from the collection filter must be performed within 96 hrs. Two approaches to eluting the particulates from the filter may be used: either washing by hand or using a stomacher.

#### **Washing By Hand:**

Step 1. Remove the filter from the inner bag and place it in a glass or stainless steel tray. Pour the residual solution in either the inner or outer bags into a pooling beaker, rinse the bags with eluting solution, add the rinse solution to the beaker and discard the bags.

Step 2. Using a razor knife or other appropriate disposable cutting instrument, cut the filter fibers lengthwise down to the core. Discard the blade, after the fibers have been cut. Divide the filter fibers into a minimum of six equal portions with one-sixth consisting of those cleanest fibers nearest the core; the second one-sixth being the second layer of fibers, and so on until the final one-sixth consisting of the outer-most filter fibers (the dirtiest fibers).

Step 3. Beginning with the cleanest fibers (the one-sixth nearest the core), hand wash the fibers in three consecutive 1.0 L volumes of eluting solution. Wash the fibers by kneading them in the eluting solution contained either in a beaker or a plastic bag. Wring the fibers to express as much of the liquid as possible before discarding. Maintain the three 1.0 L volumes of eluate separate throughout the washing procedure. An additional beaker or two with clean eluting solution may be required for extremely dirty filters.

Step 4. Using the three 1.0 L volumes of eluate from Step 3, repeat the washing procedure on the second one-sixth layer of fibers, and then continue sequentially with the remaining one-sixth layers of fibers.

Step 5. The minimum total wash time of fibers should be 30 min. After all the fibers have been washed, combine the three 1.0 L volumes of eluate with the residual filter water in the pooling beaker from Step 1. Discard the fibers.

### **Stomacher Washing:**

Step 1. Use a stomacher with a bag capacity of 3500 mL. Remove the filter from the inner bag and place it in a glass or stainless steel tray. Pour the residual solution in either the inner or outer bags into a pooling beaker, rinse the bags with eluting solution, add the rinse solution to the beaker and discard the bags. Using a razor knife or other appropriate disposable cutting instrument, cut the filter fibers lengthwise down to the core. Discard the blade, after the fibers have been cut.

Step 2. After loosening the fibers, place all the filter fibers in a stomacher bag. To insure against bag breakage and sample loss, place the filter fibers in the first stomacher bag into a second stomacher bag.

Step 3. Add 1.75 L of eluting solution to the fibers. Homogenize for 2-five minute intervals. Between each homogenization period, hand knead the filter material to redistribute the fibers in the bag.

Step 4. Pour the eluted particulate suspension into a 4 L pooling beaker. Wring the fibers to express as much of the liquid as possible into the pooling beaker.

Step 5. Put the fibers back into the stomacher bag, add 1.0 L more eluting solution, and homogenize, as in Step 3 above, for 2-five minute intervals. Between each homogenization period, hand knead the filter material to redistribute the fibers in the bag.

Step 6. Add the eluted particulate suspension to the 4 L pooling beaker. Wring the fibers to express as much of the liquid as possible into the pooling beaker. Discard the fibers. Rinse the stomacher bag with eluting solution and place this rinse water into the pooling beaker.

### **Eluate Concentration:**

Concentrate the combined eluate and residual water into a single pellet by centrifugation at  $1,050 \times g$  for 10 min using a swinging bucket rotor and plastic conical centrifuge bottles. Carefully aspirate and discard the supernatant fluid and resuspend the pellet in sufficient elution solution by vortexing. After pooling the particulates in one conical bottle, centrifuge once more at  $1,050 \times g$  for 10 min and record the packed pellet volume. Carefully aspirate and

discard the supernatant fluid and resuspend the pellet by vortexing in an equal volume of 10% neutral buffered formalin solution. If the packed pellet volume is less than 0.5 mL, bring the pellet and solution volume to 0.5 mL with eluting solution before adding enough 10% buffered formalin solution to bring the resuspended pellet volume to 1.0 mL.

At this point, a break may be inserted if the procedure is not going to progress immediately to the FLOTATION PURIFICATION procedure below. If a break is inserted at this point, be sure to store the formalin treated sample at 4°C for not more than 72 hours.

### FLOTATION PURIFICATION

Step 1. In a clear plastic 50 mL conical centrifuge tube(s), vortex a volume of resuspended pellet equivalent to not more than 0.5 mL of packed pellet volume with a sufficient volume of eluting solution to make a final volume of 20 mL.

Step 2. Using a 50 mL syringe and 14 gauge cannula, underlay the 20 mL vortexed suspension of particulates with 30 mL Percoll-sucrose flotation solution (sp. gr. 1.10).

Step 3. Without disturbing the pellet suspension/Percoll-sucrose interface, centrifuge the preparation at 1,050 ×g for 10 min using a swinging bucket rotor. Slowly accelerate the centrifuge over a 30-sec interval up to the speed where the tubes are horizontal to avoid disrupting the interface. Similarly, at the end of centrifugation, decelerate slowly. DO NOT USE THE BRAKE.

Step 4. Using a polystyrene 25 mL pipet rinsed with eluting solution, draw off the top 20 mL particulate suspension layer, the interface, and 5 mL of the Percoll-sucrose below the interface. Place all these volumes in a plastic 50 mL conical centrifuge tube.

Step 5. Add additional eluting solution to the plastic conical centrifuge tube (Step 4) to a final volume of 50 mL. Centrifuge at 1,050 ×g for 10 min.

Step 6. Aspirate and discard the supernatant fluid down to 5 mL (plus pellet). Resuspend the pellet by vortexing and save this suspension for further processing with fluorescent antibody reagents.

### INDIRECT FLUORESCENT ANTIBODY (IFA) PROCEDURE

#### **Determining Sample Volume per Filter (optional):**

Step 1. Determine the volume of sample concentrate from the Flotation Purification procedure above that may be applied to each 25-mm diameter membrane filter used in the IFA assay.

Step 2. Vortex the sample concentrate and apply 40  $\mu$ L to one 5-mm diameter well of a 12-well red heavy teflon-coated slide<sup>9</sup>.

Step 3. Allow the sample to sit approximately two min at room temperature.

Step 4. Examine the flooded well at 200X total magnification. If the particulates are distributed evenly over the well surface area and are not crowded or touching, then apply 1 mL of the undiluted sample to a 25-mm diameter membrane filter in Step 6 of **Sample Application** below.

Step 5. Adjust the volume of the sample accordingly if the particulates are too dense or are widely spread. Retest on another well. Always adjust the sample concentrate volume so that the density of the particulates is just a little sparse. If the layer of sample particulates on the membrane filters is too dense, any cysts or oocysts present in the sample may be obscured during microscopic examination. Make sure the dilution factor, if any, from this Step is recorded.

### **Preparing the Filtration Manifold:**

Step 1. See **Figure VII-3** for a diagram of the filtration manifold assembly.

Step 2. Connect the filtration manifold to the vacuum supply using a vacuum tube containing a "T"-shaped tubing connector. Attach a Hoffman screw clamp to 4-6 cm of latex tubing and then attach the latex tubing to the stem of the "T" connector. The screw clamp is used as a bleeder valve to regulate the vacuum to 2-4 inches (5-10 cm) of Hg.

Step 3. Close all the manifold valves and open the vacuum all the way. Using the bleeder valve on the vacuum tubing, adjust the applied vacuum to 2-4 inches (5-10 cm) of Hg. Once adjusted, do not readjust the bleeder valve during filtration. If necessary, turn the vacuum on and off during filtration at the vacuum source.

### **Membrane Filter Preparation:**

Step 1. One Sartorius 25 mm diameter cellulose acetate filter, 0.2  $\mu$ m pore size and one 25-mm diameter ethanol compatible membrane support filter, any porosity, are required for each 1 mL of adjusted suspension obtained in the **Determining Sample Volume per Filter** section of **Part 10**. Soak the required number of each type of filter separately in Petri dishes filled with 1X PBS. Drop the filters, handling them with blunt-end filter forceps, one by one flat on the surface of the buffer. Once the filters are wetted, push the filters under the fluid surface with the forceps. Allow filters to soak for a minimum of one minute before use.

---

<sup>9</sup>Cel-line Associates, Inc., 33 Gorgo Lane, Newfield, NJ 08344, Cat. #10-111.



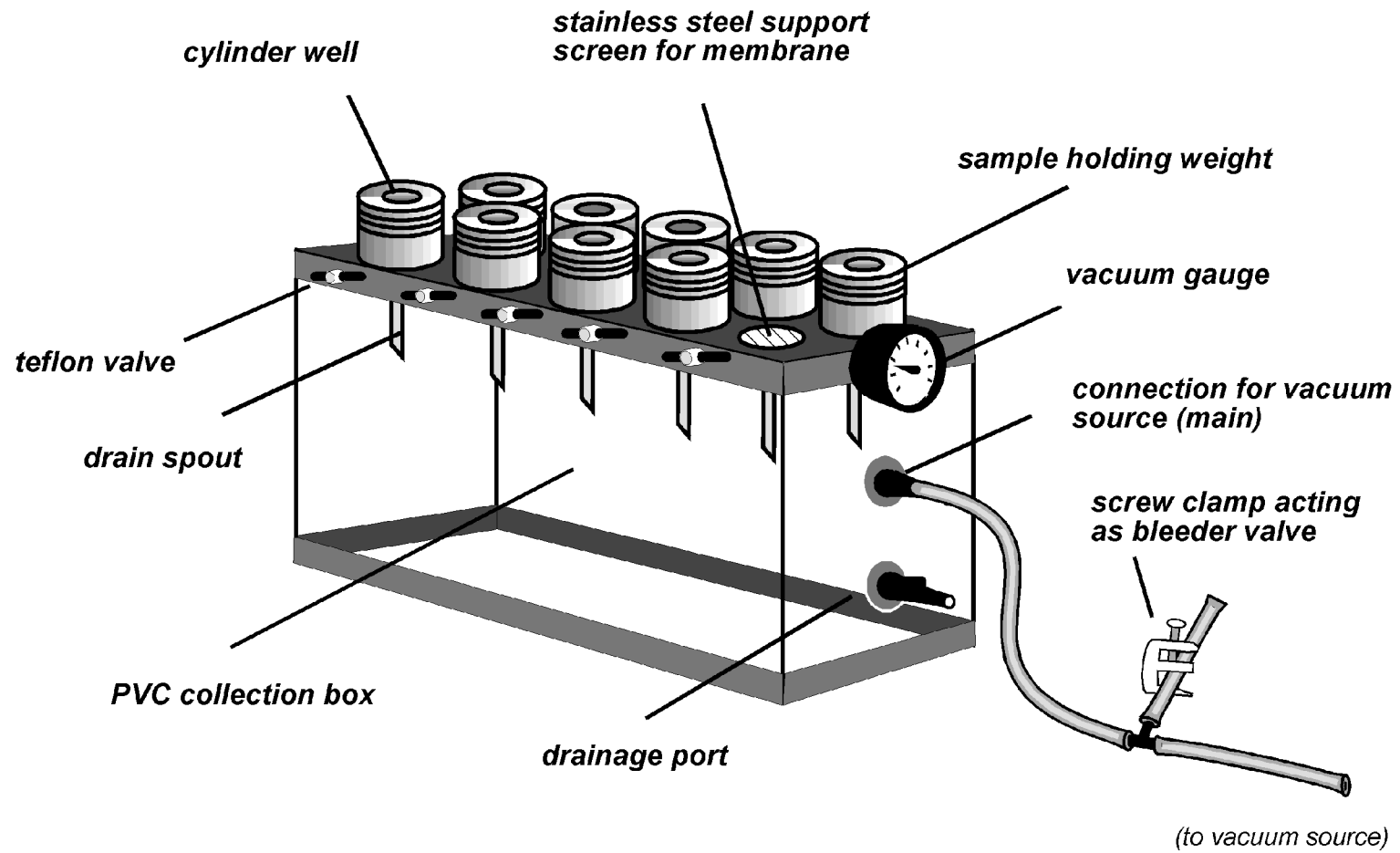

**Figure VII-3.**  
**Ten-Place Manifold with Stainless Steel Wells (Hoefer Model FH 255V)**

Step 2. Turn the filtration manifold vacuum source on. Leaving all the manifold well support valves closed, place one support filter on each manifold support screen. This filter ensures even distribution of sample.

Step 3. Place one Sartorius 25-mm diameter cellulose acetate filter on top of each support filter. Use a rubber policeman to adjust the cellulose acetate filter, if necessary. Open the manifold well support valves to flatten the filter membranes. Make sure that no bubbles are trapped and that there are no creases or wrinkles on any of the filter membranes.

Step 4. Use as many filter positions as there are sample volumes to be assayed. Record the number of sample 25-mm membrane filters prepared and the volume of floated pellet (either determined from the optional **Determining Sample Volume per Filter** step or determined by the discretion of the principal analyst) represented by these membranes. In addition, include at least one positive control for *Giardia* cysts and *Cryptosporidium* oocysts and one negative control each time the manifold is used.

Step 5. Position the 1 lb (454 g) stainless steel wells firmly over each filter.

Step 6. Label each sample and control well appropriately with little pieces of tape on the top of the stainless steel wells and/or use manifold membrane labeling diagram (**Figure VII-4**) to keep track of each sample and control.

### **Sample Application:**

Step 1. Open the manifold support valve for each well containing filters.

Step 2. Rinse the inside of each stainless steel well and membrane filter with 2 mL 1% BSA applied with a Pasteur pipet. Drain the BSA solution completely from the membrane.

Step 3. Close the manifold valves under each membrane filter.

Step 4. For the positive controls, add 500-1000 *Giardia lamblia* cysts and 500-1000 *Cryptosporidium parvum* oocysts or use the Ensys positive control antigen as specified in the kit to a well.

Step 5. For a negative control, add 1.0 mL 1X PBS to one well.

Step 6. Add 1.0 mL of the vortexed, adjusted water sample (**Determining Sample Volume per Filter; Part 10**) to a well. If the optional step to determine sample volume was not performed, add the volume determined by the principal analyst to be appropriate to a well.

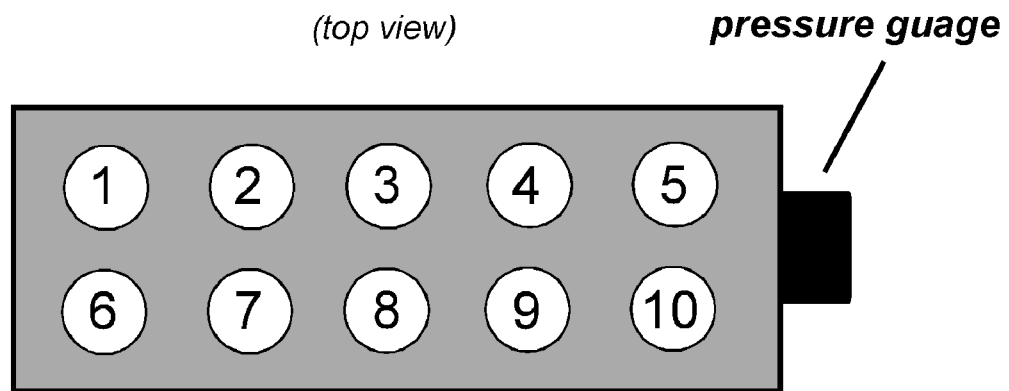

- 1. \_\_\_\_\_
- 2. \_\_\_\_\_
- 3. \_\_\_\_\_
- 4. \_\_\_\_\_
- 5. \_\_\_\_\_

- 6. \_\_\_\_\_
- 7. \_\_\_\_\_
- 8. \_\_\_\_\_
- 9. \_\_\_\_\_
- 10. \_\_\_\_\_

*Figure VII-4.  
Ten-Place Hoefer Manifold Membrane Labeling Diagram*

Step 7. Open the manifold valve under each membrane filter to drain the wells. Rinse each stainless steel well with 2 mL 1% BSA. Do not touch the pipet to the membrane filter or to the well. Close the manifold valve under each membrane filter.

### **Indirect Fluorescent Antibody Staining:**

Step 1. Dilute the primary antibody mixture and labeling reagent according to the manufacturer's instructions using 1X PBS.

Step 2. Pipet 1.0 mL of the diluted primary antibody onto each membrane and allow to remain in contact with the filter for 25 min at room temperature.

Step 3. At the end of the contact period, open the manifold valve to drain the antisera.

Step 4. Rinse each well and filter 5 times with 2 mL 1X PBS. Do not touch the tip of the pipet to the membrane filter or to the stainless steel wells. Close all manifold valves after the last wash is completed.

Step 5. Pipet 1.0 mL labeling reagent onto each membrane and allow to remain in contact with the filter for 25 min at room temperature. Cover all wells with aluminum foil to shield the reagents from light and to prevent dehydration and crystallization of the fluorescein isothiocyanate dye during the contact period.

Step 6. At this point, start the **Filter Mounting** procedure below.

Step 7. At the end of the contact period, open the manifold valves to drain the labeling reagent.

Step 8. Rinse each well and filter 5 times with 2 mL 1X PBS. Do not touch the tip of the pipet to the membrane filter or to the stainless steel wells. Close all manifold valves after the last wash is completed.

Step 9. Dehydrate the membrane filters in each well by sequentially applying 1.0 mL of 10, 20, 40, 80 and 95% ethanol solutions containing 5% glycerol. Allow each solution to drain thoroughly before applying the next in the series.

### **Filter Mounting:**

Step 1. Label glass slides for each filter and place them on a slide warmer or in an incubator calibrated to 37°C.

Step 2. Add 75  $\mu$ L 2% DABCO-glycerol mounting medium to each slide on the slide warmer or in the incubator and allow to warm for 20-30 min.

Step 3. Remove the top cellulose acetate filter with fine-tip forceps and layer it over the correspondingly labeled DABCO-glycerol mounting medium prepared slide. Make sure the sample application side is up. If the entire filter is not wetted by the DABCO-glycerol mounting medium, pick up the membrane filter with the same forceps and add a little more DABCO-glycerol mounting medium to the slide under the filter. Place the mounted filter either on the slide warmer or in the incubator for a clearing period of 20 min.

Step 4. Use a clean pair of forceps to handle each membrane filter. Soak used forceps in a beaker of diluted detergent cleaning solution.

Step 5. After the 20 min clearing period, the filter should become transparent and appear drier. After clearing, if the membrane starts to turn white, apply a small amount of DABCO-glycerol mounting medium under the filter.

Step 6. After the 20 min clearing period, apply 20  $\mu$ L DABCO-glycerol mounting medium to the center of each membrane filter and cover with a 25 mm  $\times$  25 mm cover glass. Tap out air bubbles with the handle end of a pair of forceps. Wipe off excess DABCO-glycerol mounting medium from the edge of each cover glass with a slightly moistened Kimwipe.

Step 7. Seal the edge of each cover glass to the slide with clear fingernail polish.

Step 8. Store the slides in a "dry box". A dry box can be constructed from a covered Tupperware®-type container to which a thick layer of anhydrous calcium sulfate has been added. Cover the desiccant with paper towels and lay the slides flat on the top of the paper towels. Place the lid on the dry box and store at 4°C.

Step 9. Examine the slides microscopically as soon as possible but within 5 days of preparation, because they may become opaque if stored longer, and D.I.C. or Hoffman modulation® optical examination would then no longer be possible.

### **Microscopic Examination:**

1. General: Microscopic work by a single analyst should not exceed **four** hours per day nor more than **five** consecutive days/week. Intermittent rest periods during the four hours per day are encouraged.

Step 1. Remove the dry box from 4°C storage and allow it to warm to room temperature before opening.

Step 2. Adjust the microscope to assure that the epifluorescence and Hoffman modulation® or D.I.C. optics are in optimal working order. Make sure that the fluorescein isothiocyanate cube is in place in the epifluorescent portion of the microscope (see

SAMPLE EXAMINATION in **Part 6**). Detailed procedures required for adjusting and aligning the microscope are found in **Appendix VII-5**.

2. IFA Controls: The purpose of these IFA controls is to assure that the assay reagents are functioning, that the assay procedures have been properly performed, and that the microscope has been adjusted and aligned properly.

a. Negative IFA Control for *Giardia/Cryptosporidium*

Step 1. Using epifluorescence, scan the negative control membrane at no less than 200X total magnification for apple-green fluorescence of *Giardia* cyst and *Cryptosporidium* oocyst shapes.

Step 2. If no apple-green fluorescing cyst or oocyst shapes are found, and if background fluorescence of the membrane is very dim or non-existent, continue with examination of the water sample slides.

If apple-green fluorescing cyst or oocyst shapes are found, discontinue examination since possible contamination of the other slides is indicated. Clean the equipment (see **Appendix VII-1**), recheck the reagents and procedure and repeat the assay using additional aliquots of the sample.

b. Positive IFA Control for *Giardia/Cryptosporidium*

Step 1. Using epifluorescence, scan the positive control slide at no less than 200X total magnification for apple-green fluorescence of *Giardia* cyst and *Cryptosporidium* oocyst shapes. Background fluorescence of the membrane should be either very dim or non-existent. *Cryptosporidium* oocysts may or may not show evidence of oocyst wall folding, which is characterized under epifluorescence by greater concentrations of FITC along surface fold lines, depending upon the manner in which the oocysts have been treated and the amount of turgidity they have been able to maintain<sup>10</sup>.

If no apple-green fluorescing *Giardia* cyst or *Cryptosporidium* oocyst shapes are observed, then the fluorescent staining did not work or the positive control cyst preparation was faulty. Do not examine the water sample slides for *Giardia* cysts and *Cryptosporidium* oocysts. Recheck reagents and procedures to determine the problem.

---

<sup>10</sup>Robertson, L.J., *et al.* 1993. Induction of folds or sutures on the walls of *Cryptosporidium parvum* oocysts and their importance as a diagnostic feature. *Appl. Environ. Microbiol.* **59**(8):2638-2641.

Step 2. If apple-green fluorescing cyst and oocyst shapes are observed, change the microscope from epifluorescence to the 100X oil immersion Hoffman modulation® or differential interference contrast objective.

At no less than 1000X total oil immersion magnification, examine *Giardia* cyst shapes and *Cryptosporidium* oocyst shapes for internal morphology.

The *Giardia* cyst internal morphological characteristics include one to four nuclei, axonemes, and median bodies. *Giardia* cysts should be measured to the nearest 0.5  $\mu\text{m}$  with a calibrated ocular micrometer. Record the length and width of cysts. Also record the morphological characteristics observed. Continue until at least 3 *Giardia* cysts have been detected and measured in this manner.

The *Cryptosporidium* oocyst internal morphological characteristics include one to four sporozoites. Examine the *Cryptosporidium* oocyst shapes for sporozoites and measure the oocyst diameter to the nearest 0.5  $\mu\text{m}$  with a calibrated ocular micrometer. Record the size of the oocysts. Also record the number, if any, of the sporozoites observed. Sometimes a single nucleus is observed per sporozoite. Continue until at least 3 oocysts have been detected and measured in this manner.

### 3. Sample Examination

Scanning Technique - Scan each slide in a systematic fashion beginning with one edge of the mount and covering the entire coverslip. An up-and-down or a side-to-side scanning pattern may be used. See **Figure VII-5** for an illustration of two alternatives for systematic slide scanning.

Step 1. Empty Counts, Counts with Amorphous Structure, Counts with Internal Structure, and Total IFA Count

- a. When appropriate responses have been obtained for the positive and negative controls, use epifluorescence to scan the entire coverslip from each sample at not less than 200X total magnification for apple-green fluorescence of cyst and oocyst shapes.
- b. When brilliant apple-green fluorescing round to oval objects (8 to 18  $\mu\text{m}$  long by 5 to 15  $\mu\text{m}$  wide) are observed with brightly highlighted edges, switch the microscope to either Hoffman modulation® or D.I.C. optics. Look for external or internal morphological characteristics atypical of *Giardia* cysts (e.g., spikes, stalks, appendages, pores, one or two large nuclei filling the cell, red fluorescing chloroplasts, crystals, spores, etc.). If these atypical structures are not observed, then categorize such apple-green fluorescing objects of the aforementioned size and shape as either empty *Giardia* cysts, *Giardia* cysts with amorphous structure, or *Giardia*

cysts with internal structures (nuclei, axonemes, and median bodies). Record the shape and measurements (to the nearest 0.5  $\mu\text{m}$  at 1000X total magnification) for each such object. Record the internal structures observed. *Giardia* cysts with internal structures must be confirmed by a senior analyst. Sum the counts of empty *Giardia* cysts, *Giardia* cysts with amorphous structure, and *Giardia* cysts with internal structures. Report this sum as the total *Giardia* IFA count on a ***Giardia* Report Form** (see **Appendix VII-3**).

c. When brilliant apple-green fluorescing ovoid or spherical objects (3 to 7  $\mu\text{m}$  in diameter) are observed with brightly highlighted edges, switch the microscope to either Hoffman modulation® or D.I.C. optics. Look for external or internal morphological characteristics atypical of *Cryptosporidium* oocysts (e.g., spikes, stalks, appendages, pores, one or two large nuclei filling the cell, red fluorescing chloroplasts, crystals, spores, etc.). If these atypical structures are not observed, then categorize such apple-green fluorescing objects of the aforementioned size and shape as either empty *Cryptosporidium* oocysts, *Cryptosporidium* oocysts with amorphous structure, or *Cryptosporidium* oocysts with internal structure (one to four sporozoites/oocyst). Record the shape and measurements (to the nearest 0.5  $\mu\text{m}$  at 1000X total magnification) for each such object. Although not a defining characteristic, surface oocyst folds may be observed in some specimens. Record the number of sporozoites observed. *Cryptosporidium* oocysts with sporozoites must be confirmed by a senior analyst. Sum the counts of empty *Cryptosporidium* oocysts, *Cryptosporidium* oocysts with amorphous structure, and *Cryptosporidium* oocysts with internal structure. Report this sum as the total *Cryptosporidium* IFA count on a ***Cryptosporidium* Report Form** (see **Appendix VII-4**).

### Calculation:

Step 1. Percentage of Floated Sample Examined - Record the percentage of floated sediment examined microscopically. [Calculate this value from the total volume of floated pellet obtained (**Part 10, FILTER ELUTION**), the number of 25-mm membrane filters prepared together with the volume of floated pellet represented by these membrane filters (**Part 10, Determining Sample Volume per Filter**), and the number of membrane filters examined.]

The following values are used in calculations:

V = volume (liters) of original water sample (**Part 9, RAW WATER SAMPLE COLLECTION** and **FINISHED WATER SAMPLE COLLECTION**)

P = eluate packed pellet volume (**Part 10, FILTER ELUTION**), (mL),



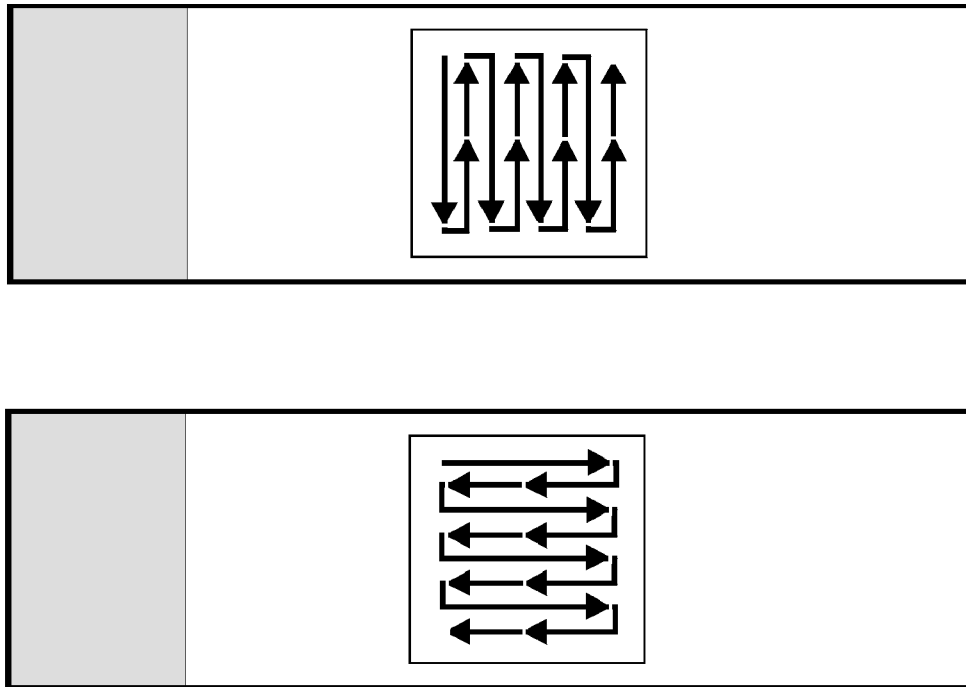

*Figure VII-5.  
Methods for Scanning Water Filter Membrane Mounted on a Glass Slide*

F = fraction of eluate packed pellet volume (P) subjected to flotation (**Part 10, FLOTATION PURIFICATION**, Steps 1-6), determined as

$$F = \frac{\text{mL } P \text{ subjected to flotation}}{P}$$

R = Percentage (expressed as a decimal) of floated sediment examined (**Part 10, Calculation**, Step 1)

TG = Total *Giardia* IFA cyst count (**Part 10, Microscopic Examination**, Section 3, Step 1. Empty Count, Count with Amorphous Structure, and Count with Internal Structure, and Total IFA Count, paragraph b)

EG = Count of *Giardia* cysts which are empty

AG = Count of *Giardia* cysts with amorphous internal structure

GW1S = Count of *Giardia* cysts with one internal structure

GW2S = Count of *Giardia* cysts with more than one internal structure

TC = Total *Cryptosporidium* IFA oocyst count

EC = Count of *Cryptosporidium* oocysts which are empty

AC = Count of *Cryptosporidium* oocysts with amorphous internal structure

CWS = Count of *Cryptosporidium* oocysts with internal structure

Step 2. For positive samples, calculate the number of cysts or oocysts per 100 L of sample as follows:

$$\frac{X}{100L} = \frac{(TG, EG, AG, GW1S, GW2S, TC, EC, AC, \text{ or } CWS)(100)}{FVR}$$

A sample calculation is shown in **Appendix VII-2**.

Step 3. For samples in which no cysts or oocysts are detected, (TG or TC or GWS or CWS) = <1. Calculate the detection limit as follows:

$$\frac{<X}{100L} = \frac{(<1)(100)}{FVR}$$

A sample calculation is shown in **Appendix VII-2**.

### **Reporting:**

Step 1. Report *Giardia* results as empty *Giardia* cysts, *Giardia* cysts with amorphous structure, *Giardia* cysts with one internal structure, and/or *Giardia* cysts with two or more internal structures, and total *Giardia* IFA count per 100 L of sample. Report *Cryptosporidium* results as empty *Cryptosporidium* oocysts, *Cryptosporidium* oocysts with amorphous structure, and/or *Cryptosporidium* oocysts with internal structure and total *Cryptosporidium* IFA count per 100 L of sample. Report negative results in terms of the detection limit. Representative reporting forms are given in **Appendix VII-3** and **Appendix VII-4**.

Step 2. Enter all data into the computer spreadsheet provided with this protocol.

### **Quality Control (QC) Samples:**

1. Negative QC Sample Preparation - This control is a check on equipment, materials, reagents and technique. It involves processing a 1 µm nominal porosity cartridge filter as if it were an unknown. All samples analyzed over the course of a week are considered to be a **batch**. For each batch, there must be a negative QC Sample.

Step 1. Process a 1 µm nominal porosity cartridge filter for *Giardia* cysts and *Cryptosporidium* oocysts using the FILTER ELUTION AND CONCENTRATION, FLOTATION PURIFICATION and INDIRECT FLUORESCENT ANTIBODY procedures.

Step 2. Examine the entire concentrate from this sample using the **Microscopic Examination** section. If any cysts or oocysts are detected, do not process any more unknown samples until the source of the contamination is located and corrected.

Note that the results from samples in a batch associated with finding a positive in a negative control will be excluded from the ICR Data Base.

2. Positive QC Sample Preparation - The purpose of this control is to assure that the laboratory can recover cysts and oocysts when they are spiked into a sample at a known level. All samples analyzed over the course of a week are considered a **batch**. For each batch, there must be a positive control.

Step 1. Seed 40 L (10.6 gal) of reagent grade water with 1000 *Giardia* cysts and 2000 *Cryptosporidium* oocysts. Pass the spiked water through a 1 µm nominal porosity cartridge filter using the procedures found in **Part 9 - Sampling**.

Step 2. Process the filtered water using the FILTER ELUTION AND CONCENTRATION, FLOTATION PURIFICATION and INDIRECT FLUORESCENT ANTI-BODY procedures.

Step 3. Examine the entire concentrate for *Giardia* cysts and *Cryptosporidium* oocysts using the **Microscopic Examination** section. It is not necessary to identify internal morphological characteristic using differential interference contrast microscopy. If cysts and oocysts are not detected, do not process any more unknown samples until the reason for not recovering cysts and oocysts is determined and corrected. Note that the results from samples in a batch associated with not finding cysts and oocysts in a positive control will be excluded from the ICR Data Base.

## **PART 11 - EDUCATION, TRAINING AND PROFICIENCY**

### MINIMAL PERSONNEL REQUIREMENTS

**Principal Analyst/Supervisor:** To be qualified for approval, a laboratory must have a principal analyst who may also serve as a supervisor if an additional analyst(s) is to be involved. The principal analyst/supervisor oversees the entire analyses and carries out QC performance checks on technicians and/or other analysts. The principal analyst/supervisor must confirm all protozoan internal structures demonstrated at the microscope by subordinates. This person must be an experienced microbiologist with at least a B.A./B.S. degree in microbiology or a closely related field. The principal analyst also must have at least one year of continuous bench experience with immunofluorescent antibody (IFA) techniques and microscopic identification and have analyzed at least 100 water and/or wastewater samples for *Giardia* and/or *Cryptosporidium*. In addition, PE samples must be analyzed using the ICR protozoan method and results must fall within acceptance limits. The principal analyst/supervisor must also demonstrate acceptable performance during an on-site evaluation.

**Analyst:** This person(s) performs at the bench level under the supervision of a principal analyst/supervisor and is involved in all aspects of the analysis, including preparation of sampling equipment, filter extraction, sample processing, microscopic protozoan identification, and data handling. Recording presence or absence of morphological characteristics may be done by the analyst but must be confirmed by the principal analyst. The analyst must have two years of college lecture and laboratory course work in microbiology or a closely related field. The analyst also must have at least six months bench experience, must have at least three months experience with IFA techniques, and must have successfully analyzed at least 50 water and/or wastewater samples for *Giardia* and/or *Cryptosporidium*. Six months of additional bench experience in the above areas may be substituted for two years of college. In addition, PE samples must be analyzed using the ICR protozoan method and results must fall within acceptance limits. The analyst must also demonstrate acceptable performance during an on-site evaluation.

**Technician:** This person extracts filters and processes the samples under the supervision of an analyst, but does not perform microscopic protozoan detection and identification. The technician must have at least three months experience in filter extraction and processing of protozoa samples.

## **PART 12 - KEY WORDS**

Antibody, *Cryptosporidium parvum*, cysts, fluorescence, *Giardia*, immunoassay, oocysts, protozoa

## **Appendix VII-1. CLEANING THE MANIFOLD AND WELLS**

### MANIFOLD

- Step 1. After all the membrane filters have been mounted on glass slides (**Part 10, Filter Mounting**, Step 8), remove the support filters and discard them.
- Step 2. Open all the manifold valves and increase the vacuum pressure to the manifold by closing the bleeder valve associated with the vacuum tubing.
- Step 3. Rinse each manifold filter support screen with 10-20 mL of 0.01% Tween 80 solution and then with 10-20 mL of water.
- Step 4. Disconnect the manifold from the vacuum and wash the cover and fluid collection box in warm detergent solution. Rinse with tap water and reagent water.

### STAINLESS STEEL WELLS

- Step 1. Place a cloth on the bottom of an autoclavable container which is large enough to accommodate all 10 stainless steel wells in a single layer.
- Step 2. Put the stainless steel wells top side down on the cloth. The rim on the underside of the well is fragile. Care must be taken to avoid scratching and denting the rim.
- Step 3. Add enough reagent water containing detergent to cover the stainless steel wells by an inch or more.
- Step 4. Autoclave the stainless steel container with the stainless steel wells for 15 min at 15 lb/in<sup>2</sup> and 121 °C. Use the slow exhaust mode at the completion of the autoclave cycle. This step does not destroy cysts and oocysts, but aids the detergent in removing them.
- Step 5. Transfer the wells to a pan of hot detergent cleaning solution.
- Step 6. Vigorously scrub the inside and bottom of each stainless steel well with a sponge or brush. Note that this step is the most important part of the well cleaning procedure.
- Step 7. Rinse each well with tap water followed by reagent water. Drain and air dry the wells.
- Step 8. Always check the bottom ridge of each stainless steel well for dents and scratches.
- Step 9. If dents or scratches are found on the bottom of a stainless steel well, do not use it until it is properly reground.

## Appendix VII-2. SAMPLE CALCULATION

### POSITIVE SAMPLES

Assume that a 100 gal (380 L) water sample was collected. The sample was eluted resulting in 5 mL of sediment. Fifty percent (2.5 mL) of the sediment was purified by Percoll-sucrose flotation. Forty percent of the floated material was examined microscopically. A total of 8 empty and 3 *Giardia* cysts with one internal structure were found. No *Cryptosporidium* oocysts were observed. Using the formula in **Part 10, Calculation**:

$$\begin{aligned} V &= 380 \text{ L} \\ P &= 5 \text{ mL} \\ F &= 2.5/5 = 0.5 \\ R &= 40\% = 0.4 \\ TG &= 11 \\ GWIS &= 3 \end{aligned}$$

$$\begin{aligned} \frac{\textit{Giardia cysts with structures}}{100 \text{ L}} &= \frac{(GWIS)(100)}{FVR} \\ &= \frac{(3)(100)}{(0.5)(380)(0.4)} \\ &= 4 ; \end{aligned}$$

and

$$\begin{aligned} \frac{\textit{Total IFA Giardia cysts}}{100 \text{ L}} &= \frac{(TG)(100)}{FVR} \\ &= \frac{(11)(100)}{(0.5)(380)(0.4)} \\ &= 14 \end{aligned}$$

## NEGATIVE SAMPLES

Using the description for POSITIVE SAMPLES given above, no *Cryptosporidium* oocysts were observed. The calculated detection limit per 100 L would be:

$$\begin{aligned}\frac{\text{Total IFA } \textit{Cryptosporidium} \textit{ oocysts}}{100 \text{ L}} &= \frac{(TC)(100)}{\text{FVR}} \\ &= \frac{(<1)(100)}{(0.5)(380)(0.4)} \\ &= <1.3\end{aligned}$$



### Appendix VII-3. *GIARDIA* REPORT FORM

Slide Prepared by:					Date Prepared:			
Analyst:					Date Analyzed:			
Object Located by IFA  No.	Shape (oval or round)	Size L×W (μm)	Empty <i>Giardia</i> Cysts (✓) (A)	<i>Giardia</i> Cysts with Amorphous Structure (✓) (B)	<i>Giardia</i> Cysts with Internal Structure (C)			Total IFA <i>Giardia</i> Count (✓) (D = A+B+C)
					Morphological Characteristics			
					Nucleus (#)	Median Body (✓)	Axonemes (✓)	
1								
2								
3								
4								
5								
6								
7								
8								
9								
10								
Total					# with one morph. char.			
					# with > one morph. char.			
A. Calculated Number of Empty <i>Giardia</i> Cysts/100 L								
B. Calculated Number of <i>Giardia</i> Cysts with Amorphous Structure/100 L								
C. Calculated Number of <i>Giardia</i> Cysts with one Internal Structure/100 L								
D. Calculated Number of <i>Giardia</i> Cysts with more than one Internal Structure/100 L								
E. Calculated Total IFA <i>Giardia</i> Count /100 L								

**Appendix VII-4. *CRYPTOSPORIDIUM* REPORT FORM**

Slide Prepared By:					Date Prepared:	
Analyst:					Date Analyzed:	
Object Located by IFA  No.	Shape (oval or round)	Size L×W (µm)	Empty <i>Cryptosporidium</i> Oocysts (✓) (A)	<i>Cryptosporidium</i> Oocysts with Amorphous Structure (✓) (B)	<i>Cryptosporidium</i> Oocysts with Internal Structure (C)	Total IFA <i>Cryptosporidium</i> Count (✓) (D = A+B+C)
					Morphological Characteristics	
					Sporozoite (#)	
1						
2						
3						
4						
5						
6						
7						
8						
9						
10						
Total						
A. Calculated Number of Empty <i>Cryptosporidium</i> Oocysts/100 L						
B. Calculated Number of <i>Cryptosporidium</i> Oocysts with Amorphous Structure/100 L						
C. Calculated Number of <i>Cryptosporidium</i> Oocysts with Internal Structure/100 L						
D. Calculated Total IFA <i>Cryptosporidium</i> Count/100 L						

## Appendix VII-5. MICROSCOPE ADJUSTMENTS <sup>11</sup>

The microscopic portion of this procedure depends upon very sophisticated optics. Without proper alignment and adjustment of the microscope the instrument will not function at maximal efficiency and the probability of obtaining the desired image (information) will not be possible. Consequently, it is imperative the all portions of the microscope from the light sources to the oculars are properly adjusted.

While microscopes from various vendors are configured somewhat differently, they all operate on the same general physical principles. Therefore, slight deviations or adjustments may be required to make these guidelines work for the particular instrument at hand.

### EPIFLUORESCENT MERCURY BULB AND TRANSMITTED LIGHT BULB FILAMENT ADJUSTMENT

The sole purpose of these procedures is to insure even field illumination.

#### **Mercury Bulb Adjustment:**

This section assumes that you have successfully replaced the mercury bulb in your particular lamp socket and reconnected the lamp socket to the lamp house. These instructions also assume the condenser has been adjusted to produce Köhler illumination. Make sure that you have not touched any glass portion of the mercury bulb with your bare fingers while installing it. **WARNING:** Never look at the ultraviolet light coming out of the mercury lamp house or the ultraviolet light image without a barrier filter in place.

Step 1. Usually there is a diffuser lens between the lamp and the microscope which either must be removed or swung out of the light path.

Step 2. Using a prepared microscope slide, adjust the focus so the image in the oculars is sharply defined.

Step 3. Replace the slide with a business card or a piece of lens paper.

Step 4. Close the field diaphragm (iris diaphragm in the microscope base) so only a small point of light is visible on the card. This dot of light tells you where the center of the field of view is.

Step 5. Mount the mercury lamp house on the microscope without the diffuser lens in place and turn on the mercury bulb.

Step 6. Remove the objective in the light path from the nosepiece. You should see a primary (brighter) and secondary image (dimmer) of the mercury bulb arc on the card after focusing the image with the appropriate adjustment.

Step 7. Using the other lamp house adjustments, adjust the primary and secondary mercury bulb images so they are side by side (parallel to each other) with the transmitted light dot in between them.

Step 8. Reattach the objective to the nosepiece.

---

<sup>11</sup>Smith, R.F. 1982. Microscopy and Photomicrography: A Practical Guide. Appleton-Century-Crofts, New York.

Step 9. Insert the diffuser lens into the light path between the mercury lamp house and the microscope.

Step 10. Turn off the transmitted light, remove the card from the stage, and replace it with a slide of fluorescent material. Check the field for even fluorescent illumination. Adjustment of the diffuser lens will most likely be required. Additional slight adjustments as in Step 6 above may be required.

Step 11. Maintain a log of the number of hours the U.V. bulb has been used. Never use the bulb for longer than it has been rated. Fifty watt bulbs should not be used longer than 100 hours; 100 watt bulbs should not be used longer than 200 hours.

### **Transmitted Bulb Adjustment:**

This section assumes that you have successfully replaced the transmitted bulb in your particular lamp socket and reconnect the lamp socket to the lamp house. Make sure that you have not touched any glass portion of the transmitted light bulb with your bare fingers while installing it. These instructions also assume the condenser has been adjusted to produce Köhler illumination.

Step 1. Usually there is a diffuser lens between the lamp and the microscope which either must be removed or swung out of the light path. Reattach the lamp house to the microscope.

Step 2. Using a prepared microscope slide and a 40X (or similar) objective, adjust the focus so the image in the oculars is sharply defined.

Step 3. Without the ocular or Bertrand optics in place the pupil and filament image inside can be seen at the bottom of the tube.

Step 4. Focus the lamp filament image with the appropriate adjustment on your lamp house.

Step 5. Similarly, center the lamp filament image within the pupil with the appropriate adjustment(s) on your lamp house.

Step 6. Insert the diffuser lens into the light path between the transmitted lamp house and the microscope.

### **ADJUSTMENT OF INTERPUPILLARY DISTANCE AND OCULARS FOR EACH EYE**

These adjustments are necessary, so eye strain is reduced to a minimum. These adjustments must be made for each individual using the microscope. This section assumes the use of a binocular microscope.

### **Interpupillary Distance:**

The spacing between the eyes varies from person to person and must be adjusted for each individual using the microscope.

Step 1. Place a prepared slide on the microscope stage, turn on the transmitted light, and focus the specimen image using the coarse and fine adjustment knobs.

Step 2. Using both hands, adjust the oculars in and out until a single circle of light is observed while looking through the two oculars with both eyes.

## Ocular Adjustment for Each Eye.:

This section assumes a focusing ocular(s). This adjustment can be made two ways, depending upon whether or not the microscope is capable of photomicrography and whether it is equipped with a photographic frame which can be seen through the binoculars. Precaution: Persons with astigmatic eyes should always wear their contact lenses or glasses when using the microscope.

1. For microscopes not capable of photomicrography. This section assumes only the right ocular is capable of adjustment.
  - Step 1. Place a prepared slide on the microscope stage, turn on the transmitted light, and focus the specimen image using the coarse and fine adjustment knobs.
  - Step 2. Place a card between the right ocular and eye keeping both eyes open. Using the fine adjustment, focus the image for the left eye to its sharpest point.
  - Step 3. Now transfer the card to between the left eye and ocular. Keeping both eyes open, bring the image for the right eye into sharp focus by adjusting the ocular collar at the top of the ocular, without touching the coarse or fine adjustment.
2. For microscopes capable of viewing a photographic frame through the viewing binoculars. This section assumes both oculars are adjustable.
  - Step 1. Place a prepared slide on the microscope stage, turn on the transmitted light, and focus the specimen image using the coarse and fine adjustment knobs.
  - Step 2. After activating the photographic frame, place a card between the right ocular and eye keeping both eyes open. Using the correction (focusing) collar on the left ocular focus the left ocular until the double lines in the center of the frame are as sharply focused as possible.
  - Step 3. Now transfer the card to between the left eye and ocular. Again keeping both eyes open, bring the image of the double lines in the center of the photographic frame into as sharp a focus for the right eye as possible by adjusting the ocular correction (focusing) collar at the top of the right ocular.

## CALIBRATION OF AN OCULAR MICROMETER<sup>12</sup>

This section assumes that an ocular reticle has been installed in one of the oculars by a microscopy specialist and that a stage micrometer is available for calibrating the ocular micrometer (reticle). Once installed the ocular reticle should be left in place. The more an ocular is manipulated the greater the probability is for it to become contaminated with dust particles. This calibration should be done for each objective in use on the microscope. If there

---

<sup>12</sup>Melvin, D.M. and M.M. Brooke. 1982. Laboratory Procedures for the Diagnosis of Intestinal Parasites. U.S. Department of Health and Human Services, HHS Publication No. (CDC) 82-8282.

is an optivar<sup>13</sup> on the microscope, then the calibration procedure must be done for the respective objective at each optivar setting.

Step 1. Place the stage micrometer on the microscope stage, turn on the transmitted light, and focus the micrometer image using the coarse and fine adjustment knobs for the objective to be calibrated. Continue adjusting the focus on the stage micrometer so you can distinguish between the large (0.1 mm) and the small (0.01 mm) divisions.

Step 2. Adjust the stage and ocular with the micrometer so the 0 line on the ocular micrometer is exactly superimposed on the 0 line on the stage micrometer.

Step 3. Without changing the stage adjustment, find a point as distant as possible from the two 0 lines where two other lines are exactly superimposed.

Step 4. Determine the number of ocular micrometer spaces as well as the number of millimeters on the stage micrometer between the two points of superimposition.

For example: Suppose 48 ocular micrometer spaces equal 0.6 mm.

Step 5. Calculate the number of mm/ocular micrometer space.

For example:

$$\frac{0.6 \text{ mm}}{48 \text{ ocular micrometer spaces}} = \frac{0.0125 \text{ mm}}{\text{ocular micrometer space}}$$

Step 6. Since most measurements of microorganisms are given in  $\mu\text{m}$  rather than mm, the value calculated above must be converted to  $\mu\text{m}$  by multiplying it by 1000  $\mu\text{m}/\text{mm}$ .

For example:

$$\frac{0.0125 \text{ mm}}{\text{Ocular Micrometer Space}} \times \frac{1,000 \mu\text{m}}{\text{mm}} = \frac{12.5 \mu\text{m}}{\text{Ocular Micrometer Space}}$$

Step 7. Follow Steps 1 through 6 for each objective. It is helpful to record this information in a tabular format, like the example below, which can be kept near the microscope.

---

<sup>13</sup>A device between the objectives and the oculars that is capable of adjusting the total magnification.

Item #	Obj. Power	Description	No. of Ocular Microm. Spaces	No. of Stage Microm. mm <sup>a</sup>	$\mu\text{m}/\text{Ocular Micrometer Space}^b$
1	10X	N.A. <sup>c</sup> =			
2	20X	N.A. =			
3	40X	N.A. =			
4	100X	N.A. =			

<sup>a</sup> 1000  $\mu\text{m}/\text{mm}$   
<sup>b</sup> (Stage Micrometer length in mm  $\times$  (1,000  $\mu\text{m}/\text{mm}$ ))  $\div$  No. Ocular Micrometer Spaces  
<sup>c</sup> N.A. stands for numerical aperture. The numerical aperture value is engraved on the barrel of the objective.

### KÖHLER ILLUMINATION

This section assumes that Köhler illumination will be established for only the 100X oil D.I.C. or Hoffman modulation® objective which will be used to identify internal morphological characteristics in *Giardia* cysts and *Cryptosporidium* oocysts. If by chance more than one objective is to be used for either D.I.C. or Hoffman modulation® optics, then each time the objective is changed, Köhler illumination must be reestablished for the new objective lens. Previous sections have adjusted oculars and light sources. This section aligns and focuses the light going through the condenser underneath the stage at the specimen to be observed. If Köhler illumination is not properly established, then D.I.C. or Hoffman modulation® optics will not work to their maximal potential. These Steps need to become second nature and must be practiced regularly until they are a matter of reflex rather than a chore.

Step 1. Place a prepared slide on the microscope stage, place oil on the slide, move the 100X oil objective into place, turn on the transmitted light, and focus the specimen image using the coarse and fine adjustment knobs.

Step 2. At this point both the radiant field diaphragm in the microscope base and the aperture diaphragm in the condenser should be wide open. Now close down the radiant field diaphragm in the microscope base until the lighted field is reduced to a small opening.

Step 3. Using the condenser centering screws on the front right and left of the condenser, move the small lighted portion of the field to the center of the visual field.

Step 4. Now look to see whether the leaves of the iris field diaphragm are sharply defined (focused) or not. If they are not sharply defined, then they can be focused distinctly by changing the height of the condenser up and down with the condenser focusing knob while you are looking through the binoculars. Once you have accomplished the precise focusing of the radiant field diaphragm leaves, open the radiant field diaphragm until the leaves just disappear from view.

Step 5. The aperture diaphragm of the condenser is adjusted now to make it compatible with the total numerical aperture of the optical system. This is done by removing an ocular, looking into the tube at the rear focal plane of the objective, and stopping down the aperture diaphragm iris leaves until they are visible just inside the rear plane of the objective.

Step 6. After completing the adjustment of the aperture diaphragm in the condenser, return the ocular to its tube and proceed with the adjustments required to establish either D.I.C. or Hoffman modulation® optics.



# SECTION VIII. VIRUS MONITORING PROTOCOL FOR THE ICR

## TABLE OF CONTENTS

FOREWORD .....	VIII-3
PART 1 — SAMPLE COLLECTION PROCEDURE .....	VIII-4
APPARATUS AND MATERIALS .....	VIII-4
MEDIA AND REAGENTS .....	VIII-11
PROCEDURE .....	VIII-12
PART 2 — SAMPLE PROCESSING .....	VIII-16
QUALITY CONTROL AND PERFORMANCE EVALUATION SAMPLES ..	VIII-16
QC Samples .....	VIII-16
PE Samples .....	VIII-16
ELUTION PROCEDURE .....	VIII-17
Apparatus and Materials .....	VIII-17
Media and Reagents .....	VIII-17
Procedure .....	VIII-18
ORGANIC FLOCCULATION CONCENTRATION PROCEDURE .....	VIII-19
Apparatus and Materials .....	VIII-19
Media and Reagents .....	VIII-20
Procedure .....	VIII-20
PART 3 — TOTAL CULTURABLE VIRUS ASSAY .....	VIII-23
QUANTAL ASSAY .....	VIII-23
Apparatus and Materials .....	VIII-23
Media and Reagents .....	VIII-23
Sample Inoculation and CPE Development .....	VIII-23
Virus Quantitation: .....	VIII-27
REDUCTION OF CYTOTOXICITY IN SAMPLE CONCENTRATES .....	VIII-28
Media and Reagents .....	VIII-28
Procedure for Cytotoxicity Reduction .....	VIII-29
PART 4 — CELL CULTURE PREPARATION AND MAINTENANCE .....	VIII-30
PREPARATION OF CELL CULTURE MEDIUM .....	VIII-30
General Principles .....	VIII-30
Apparatus and Materials .....	VIII-30
Media and Reagents .....	VIII-32
Media Preparation Recipes .....	VIII-32
PREPARATION AND PASSAGE OF BGM CELL CULTURES .....	VIII-35
Vessels and Media for Cell Growth .....	VIII-35
General Procedure for Cell Passage .....	VIII-35

Procedure For Performing Viable Cell Counts .....	VIII-37
PROCEDURE FOR PRESERVATION OF BGM CELL LINE .....	VIII-38
Preparation of Cells for Storage .....	VIII-38
Procedure for Freezing Cells .....	VIII-39
Procedure for Thawing Cells .....	VIII-39
PART 5 — STERILIZATION AND DISINFECTION .....	VIII-40
GENERAL GUIDELINES .....	VIII-40
STERILIZATION TECHNIQUES .....	VIII-40
Solutions .....	VIII-40
Autoclavable Glassware, Plasticware, and Equipment .....	VIII-40
Chlorine Sterilization .....	VIII-41
PROCEDURE FOR VERIFYING STERILITY OF LIQUIDS .....	VIII-41
Media and Reagents .....	VIII-42
Verifying Sterility of Small Volumes of Liquids .....	VIII-42
Visual Evaluation of Media for Microbial Contaminants .....	VIII-42
CONTAMINATED MATERIALS .....	VIII-42
PART 6 — BIBLIOGRAPHY AND SUGGESTED READING .....	VIII-43
PART 7 — VENDORS .....	VIII-46
PART 8 — EXAMPLES .....	VIII-48
EXAMPLE 1 .....	VIII-48
EXAMPLE 2 .....	VIII-56
PART 9 — DATA SHEETS .....	VIII-63

## FOREWORD

The surface water treatment rule (40 CFR Part 141) established the maximum contamination level for enteric virus in public water systems by requiring that systems using surface water or ground water under the influence of surface water reduce the amount of virus in source water by 99.99%. The rule requirements are currently met on basis of treatment alone (e.g., disinfection and/or filtration), and thus the degree of actual protection against waterborne viral disease depends upon the source water quality. Utilities using virus-free source water or source water with low virus levels may be overtreating their water, while utilities using highly contaminated water may not be providing adequate protection. To determine more adequately the level of protection from virus infection and to reduce the levels of disinfection and disinfection byproducts, where appropriate, the U.S. EPA is requiring all utilities serving a population of over 100,000 to monitor their source water for viruses monthly for a period of 18 months. Systems finding greater than one infectious enteric virus particle per liter of source water must also monitor their finished water on a monthly basis. The authority for this requirement is Section 1445(a)(1) of the Safe Drinking Water Act, as amended in 1986.

This Virus Monitoring Protocol was developed by virologists at the U.S. EPA and modified to reflect consensus agreements from the scientific community and comments to the draft rule. The procedures contained herein do not preclude the use of additional tests for research purposes (e.g., polymerase chain reaction-based detection methods for non-cytopathic viruses).

The concentrated water samples to be monitored may contain pathogenic human enteric viruses. Laboratories performing virus analyses are responsible for establishing an adequate safety plan and must rigorously follow the guidelines on sterilization and aseptic techniques given in **Part 5**.

Analytical Reagent or ACS grade chemicals (unless specified otherwise) and deionized or distilled reagent grade water (dH<sub>2</sub>O; see Table IV-1) should be used to prepare all media and reagents. The dH<sub>2</sub>O must have a resistance of greater than 0.5 megohms-cm at 25°C, but water with a resistance of 18 megohms-cm is preferred. Water and other reagent solutions may be available commercially. For any given section of this protocol only apparatus, materials, media and reagents that are not described in previous sections are listed, except where deemed necessary. The amount of media prepared for each Part of the Protocol may be increased proportionally to the number of samples to be analyzed.

## PART 1 — SAMPLE COLLECTION PROCEDURE

### APPARATUS AND MATERIALS

*Several configurations are given below for the assembly of the filter apparatus. The standard filter apparatus will be used for all sampling, except where a prefilter, dechlorination or pH adjustment are required.*

1. Standard filter apparatus (see **Figure VIII-1**).
  - a. Parts needed (letters in bold print represent the origin of the abbreviations used to identify parts in the figures):
    - i. One BR — **B**ackflow **R**egulator (Watts Regulator<sup>1</sup> Product Series 8 — ¾" Hose Connection Vacuum Breaker).
    - ii. One SF — **S**wivel **F**emale insert with garden hose threads (United States Plastic Product No. 63003).
    - iii. Three sections of BT — **B**raided **T**ubing, ½" clear (Cole-Parmer Product No. G-06401-03).
    - iv. Six HC1 — **H**ose **C**lamps (Cole-Parmer Product No. G-06403-20).
    - v. One HF1 — **H**ose **F**itting, nylon, ⅜" male NPT × ½" tubing ID (United States Plastic Product No. 61141).
    - vi. One PR — **P**ressure **R**egulator (Watts Regulator Product No. ⅜" 26A (or 263A), Suffix B).
    - vii. One PN — **P**VC **N**ipple, ⅜" male NPT (Ryan Herco Product No. 3861-057; not required with the 263A regulator).
    - viii. One TE — **P**VC **T**EE with ⅜" female NPT ports (Ryan Herco Product No. 3805-003; not required with the 263A regulator).
    - ix. One RB1 — **R**educing **B**ushing, ⅜" NPT(M) × ¼" NPT(F) (Cole-Parmer Product No. G-06349-32; not required with the 263A regulator).

---

<sup>1</sup>See **Part 7** for addresses of the vendors listed. The vendors listed in this protocol represent one possible source for required products. Other vendors may supply the same or equivalent products.

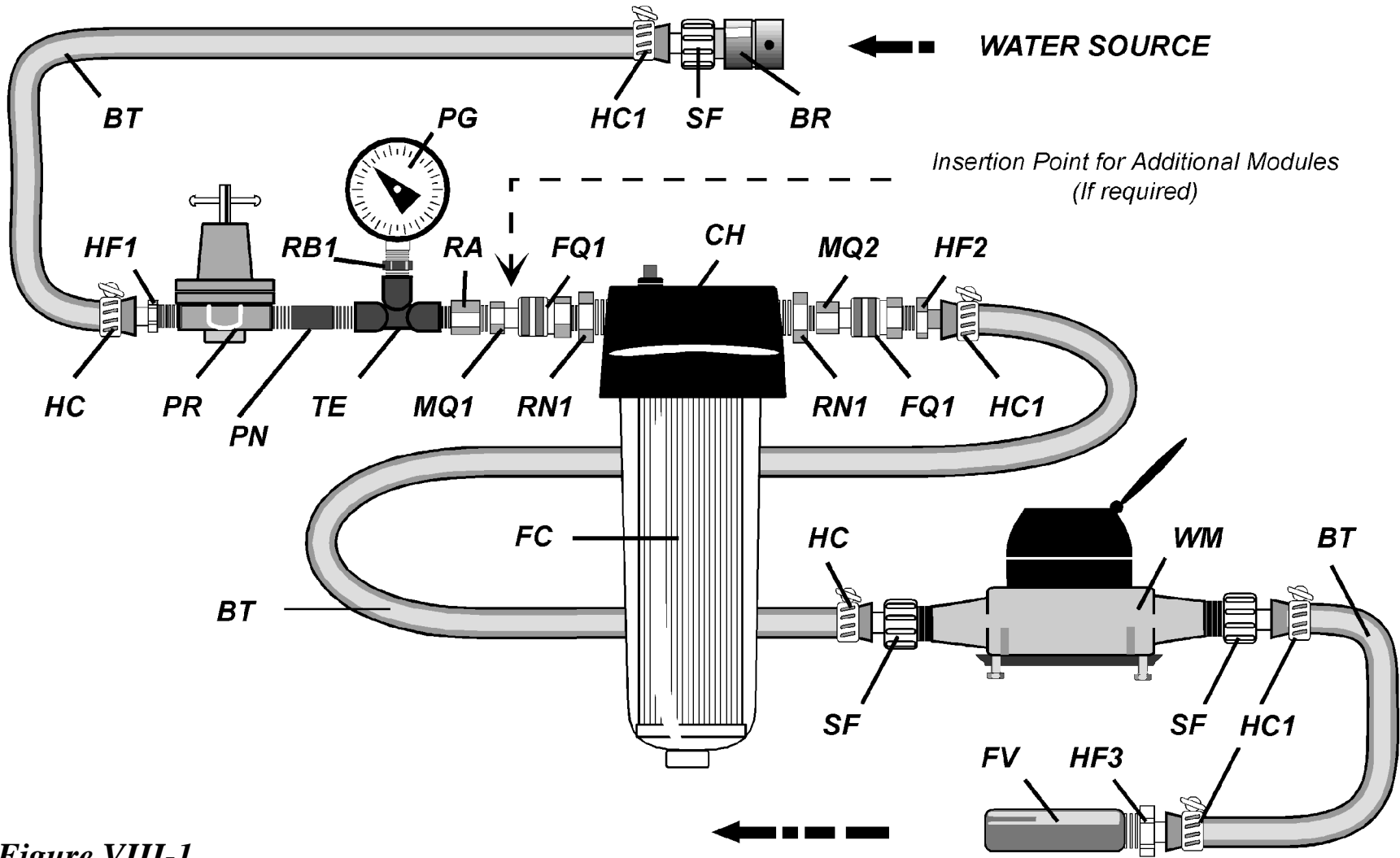

**Figure VIII-1.**  
**Standard Filter Apparatus**

- x. One PG — **P**ressure **G**auge 0-30 pound per square inch (PSI; Cole-Parmer Product No. G-68004-03; place in ¼" gauge port if using the 263A regulator).
- xi. One RA — **R**educing **A**daptor, ½" female NPT × ¾" male NPT (Cincinnati Valve and Fitting Product No. SS-8-RA-6).
- xii. One MQ1 — **M**ale **Q**uick **C**onnect, ½" male NPT (Cincinnati Valve and Fitting Product No. SS-QF8-S-8PM; appropriate hose fittings and braided tubing can be substituted for quick connects).
- xiii. Two FQ1 — **F**emale **Q**uick **C**onnects, ½" female NPT (Cincinnati Valve and Fitting Product No. SS-QF8-B-8PF).
- xiv. Two RN1 — **R**educing **N**ipples, ¾" male NPT × ½" male NPT (Cole-Parmer Product No. G-06349-35).
- xv. One CH — **C**artridge **H**ousing with wench (Cuno Product No. AP11T).
- xvi. One FC — **F**ilter **C**artridge, positively charged 1MDS, ZetaPor Virosorb (Cuno Product No. 45144-01-1MDS).
- xvii. One MQ2 — **M**ale **Q**uick **C**onnect, ½" female NPT (Cincinnati Valve and Fitting Product No. SS-QF8-S-8PF).
- xviii. One HF2 — **H**ose **F**itting, ½" male NPT × ½" tubing ID (United States Plastic Product No. 62142).
- xix. One WM — **W**ater **M**eter (Neptune Equipment Product No. ⅝" Trident 10). The water meter should be used in a horizontal position and protected from freezing. The order should specify that the meters be rated in gallons (1 gal = 0.1337 ft<sup>3</sup> or 3.7854 L). If not specified, meters may be rated in cubic feet (1 ft<sup>3</sup> = 7.481 gal or 28.316 L).
- xx. One HF3 — **H**ose **F**itting, nylon, ¾" male NPT × ½" tubing ID (United States Plastic Product No. 61143).
- xxi. One FV — **F**low **C**ontrol **V**alve (Plast-O-Matic Valves Product No. FC075B-3-PVC).

b. Apparatus assembly — the standard filter apparatus consists of three modules: the regulator module, the cartridge housing module and the discharge module.

*Teflon tape (Cole-Parmer Product No. G-08782-27) must be used on all threaded, non-compression fittings. It is recommended that apparatus assembly be performed by the analytical laboratory contracted by the utility to analyze ICR samples for viruses).*

- i. Regulator module — in order, as shown in **Figure VIII-1**, connect the backflow regulator (BR) to a swivel female insert (SF). Clamp a piece of braided tubing (BT) onto the tubing connector of the swivel female insert using a hose clamp (HC1). Clamp the other end of the tubing to a  $\frac{3}{8} \times \frac{1}{2}$ " hose fitting (HF1). Screw the fitting into the inlet of the pressure regulator (PR). Connect the outlet of the pressure regulator to the PVC TEE (TE) via a PVC nipple (PN). Connect the pressure gauge (PG) to the top of the PVC TEE using the reducing bushing (RB). Attach a reducing adaptor (RA) to the remaining connection on the PVC TEE. Add a male quick connect (MQ1) to the reducing adaptor.
- ii. Cartridge housing module — Attach a female quick connect (FQ1) to a reducing nipple (RN1). Connect the reducing nipple to the inlet of the cartridge housing (CH). Attach another reducing nipple to the outlet of the housing. Attach a male quick connect (MQ2) to the reducing adaptor.
- iii. Discharge module — attach a female quick connect (FQ1) to a hose fitting (HF2). Connect a piece of braided tubing to the hose fitting with a hose clamp (HC1). Clamp the other end of the braided tubing to a swivel female insert with another hose clamp. Attach a swivel female insert to the inlet of the water meter (WM). Attach another swivel female insert to the outlet of the meter and connect a piece of braided tubing with a hose clamp. Clamp the other end of the tubing to a hose fitting (HF3) with a hose clamp. Screw the fitting into the inlet of the flow control valve (FV). An additional hose fitting (not shown) may be added to the flow control valve for the attachment of a sufficient length of tubing to reach a drain. The discharge module does not have to be sterilized.
- iv. Connect the cartridge housing module to the regulator module at the quick connect. The combined regulator and cartridge housing modules should be sterilized with chlorine as described in **Part 5**. Presterilize a 1MDS filter cartridge (FC) as described in **Part 5** and place it into the cartridge housing using aseptic technique. Replace the housing head of the cartridge housing and tighten with a cartridge housing wench. Check to ensure that the filter is adequately sealed by shaking the housing. Adequately sealed filters should not move. For convenience during shipping, the regulator and cartridge housing modules may be separated. Seal all openings into the modules with sterile aluminum foil.

2. Prefilter module for waters exceeding 75 nephelometric turbidity units (NTU) and for any other conditions that prevent the minimum sampling volumes from being obtained (see **Figure VIII-2**).

a. Additional parts needed: One PC — 10 µm Polypropylene **P**refilter **C**artridge (Parker Hannifin Product No. M19R10-A); in addition, a female quick connect (FQ1), two reducing nipples (RN1), a cartridge housing (CH) and a male quick connect (MQ2) as described for the standard apparatus are needed.

b. Module assembly — in order, as shown for the prefilter module in **Figure VIII-2**, attach a female quick connect (FQ1) to a reducing nipple (RN1). Connect the reducing nipple to the inlet of the cartridge housing (CH). Attach another reducing nipple to the outlet of the housing. Attach a male quick connect (MQ2) to the reducing adaptor. Sterilize the unit with chlorine as described in **Part 5** and add a presterilized polypropylene prefilter cartridge using aseptic technique. Cover the ends with sterile aluminum foil. The prefilter module may be sent to the utility and stored in a clean location until needed.

3. Injector modules for source or finished water requiring pH reduction and for finished waters requiring dechlorination (see **Figure VIII-2**).

a. Additional parts needed:

- i. Two FQ2 — **F**emale **Q**uick **C**onnects, ½" male NPT (Cincinnati Valve and Fitting Product No. SS-QF8-B-8PM).
- ii. Four ME — **M**ale **E**lbows, ¾" male NPT (Cincinnati Valve and Fitting Product No. SS-6-ME).
- iii. Two RN2 — **R**educing **N**ipples, ¾" male NPT × ½" male NPT (Cole-Parmer Product No. G-6349-85).
- iv. Two RB2 — **R**educing **B**ushings, ¾" female NPT × ½" male NPT (Cole-Parmer Product No. G-06349-34).
- v. Three IN — **I**n-line **I**Njectors (DEMA Engineering Product No. 203B ¾" female NPT; a metering pump and appropriate connectors may be substituted for an injector).
- vi. Three HC2 — **H**ose **C**lamps (Cole-Parmer Product No. G-06403-10).



**Figure VIII-2.**  
*Additional Modules for the  
 Standard Filter Apparatus*

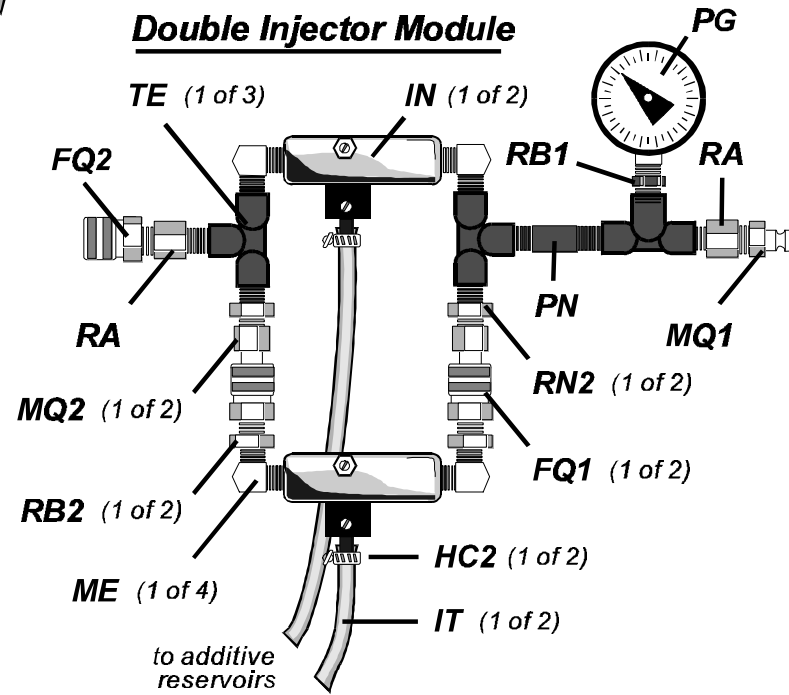
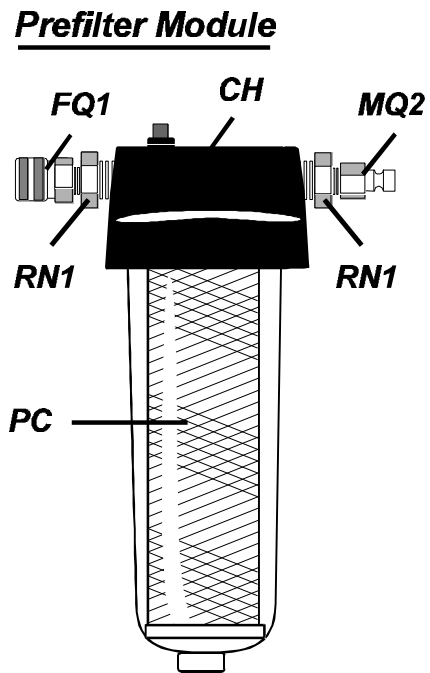
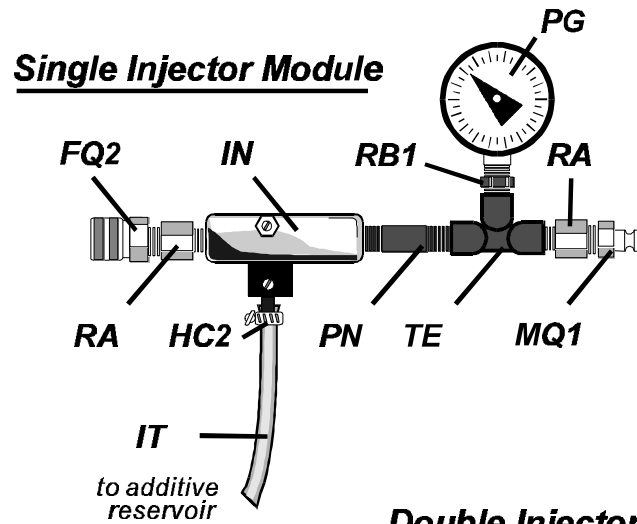

- vii. In addition, four reducing adaptors (RA), four PVC TEEs (TE), two PVC nipples (PN), two reducing bushings (RB1), two pressure gauges (PG), two female quick connects (FQ1), two male quick connects (MQ1) and two male quick connects (MQ2) as described for the standard apparatus are needed. Two union ball joints,  $\frac{3}{8}$ " female NPT (not shown; Cincinnati Valve and Fitting Product No. SS-6-UBJ) and two PVC nipples may be used in place of the two reducing nipples (RN2), male quick connects (MQ2), female quick connects (FQ1) and reducing bushings (RB2) used with the double injector module.
- b. Module assembly:
- i. Single Injector Module — assemble the parts in order as shown for the single injector module in **Figure VIII-2**. Attach a female quick connect (FQ2) to a reducing adaptor (RA). Connect the adaptor to the inlet of the injector (IN). Connect the outlet of the injector to a PVC TEE (TE) via a PVC nipple (PN). Connect a pressure gauge (PG) to the top of the PVC TEE using a reducing bushing (RB1). Attach a reducing adaptor (RA) to the remaining connection on the PVC TEE. Add a male quick connect (MQ1) to the reducing adaptor.
  - ii. Double Injector Module — assemble the parts as shown for the double injector module in **Figure VIII-2**. Assemble the main portion by attaching a female quick connect (FQ2) to a reducing adaptor (RA). Connect the adaptor to the top connector of a PVC TEE (TE). Add a male elbow (ME) to one of the connections on the PVC TEE. Attach a reducing nipple (RN2) to the other connection. If using a union ball joint in place of the quick connects, attach a PVC nipple (not shown) to the other connection. Add a male quick connect (MQ2) to the reducing nipple or add one portion of a union ball joint (not shown) to the PVC nipple. Connect the inlet side of an injector (IN) to the male elbow. Attach another male elbow to the outlet of the injector. Connect the male elbow to another PVC TEE. Connect a reducing nipple (RN2 or PVC nipple) to the other end of the second PVC TEE. Add a male quick connect (MQ2) to the reducing nipple as above (or add one portion of the second union ball joint to the PVC nipple). Connect the top connector of the second PVC TEE to a third PVC TEE via a PVC nipple (PN). Connect a pressure gauge (PG) to the top of the third PVC TEE using a reducing bushing (RB1). Attach a reducing adaptor (RA) to the remaining connection on the third PVC TEE. Add a male quick connect (MQ1) to the reducing adaptor. Attach two male elbows (ME) to the inlet and outlet of a second injector (IN). Connect two reducing bushings (RB2) or, if used, the bottom portion or the two union ball joints (not shown) to the male elbows. Connect a female quick connect (FQ1) to each reducing bushing. Orient the second injector so that the direction of flow is the same as the first injector (the arrows on the injectors should both point towards the pressure gauge side of the assembly). Connect the two female quick connects to the male

quick connects of the main portion to complete the assembly or, if used, connect the two portions of the union ball joints.

- iii. Sterilize the single and double modules with chlorine as described in **Part 5**. Cover the ends, including the injector port, with sterile aluminum foil. Sterilize the inside and outside surfaces of the **Injector Tubing (IT)**; injector tubing is supplied with each injector). Place the tubing in a sterile bag or wrapping in such a way that the ends may be removed without contaminating them. The injector modules may be shipped to the utility and stored in a clean location until needed.
4. Portable pH probe (Omega Product No. PHH-1X)
5. Portable temperature probe (Omega Product No. HH110).
6. Commercial ice packs (Cole-Parmer Product No. L-06346-85).
7. One liter polypropylene wide-mouth bottles (Nalge Product No. 2104-0032).
8. Insulated shipping box with carrying strap (17" × 17" × 13"; Cole-Parmer Product No. L-03748-00 and L-03742-30).
9. Miscellaneous — aluminum foil, data card (see **Part 9**), hosecock clamp, surgical gloves, screwdriver or pliers for clamps, waterproof marker.
10. Chemical resistant pump capable of supplying 30 PSI at 3 gal/min and appropriate connectors (for use where garden hose-type pressurized taps for the source or finished water to be monitored are unavailable and for QC samples). Follow the manufacturer's recommendations for pump priming.

#### MEDIA AND REAGENTS

1. 2% sodium thiosulfate ( $\text{Na}_2\text{S}_2\text{O}_3$ ) — dissolve 100 g of  $\text{Na}_2\text{S}_2\text{O}_3$  in a total of 5000 mL  $\text{dH}_2\text{O}$  to prepare a stock solution. Autoclave for 30 min at 121 °C.
2. Hydrochloric acid (HCl) — Prepare 0.1, 1 and 5 M solutions by mixing 50, 100 or 50 mL of concentrated HCl with 4950, 900 or 50 mL of  $\text{dH}_2\text{O}$ , respectively. Prepare solutions to be used for adjusting the pH of water samples at least 24 h before use.

## PROCEDURE

*Operators must wear surgical gloves and avoid conditions that can contaminate a sample with virus. Gloves should be changed after touching human skin or handling components that may be contaminated (e.g., water taps, other environmental surfaces).*

Step 1. Purge the water tap to be sampled before connecting the filter apparatus. Continue the purging for 3-3 min or until any debris that has settled in the tap line has cleared. Then turn off the water tap.

*Source water sampling must be conducted at the plant intake, before impoundment, chlorination or any other treatment. Finished water sampling must be conducted at the point of entry into the distribution system. If it is necessary to use a pump for sampling, sterilize the pump with chlorine as described in **Part 5** or flush with 20 gal of water to be sampled before each use.*

Step 2. Remove the foil from the backflow regulator (see **Figure VIII-1**) on a regulator module. Loosen the swivel female insert slightly to allow it to turn freely and connect the backflow regulator to the tap. Retighten the swivel female insert. Disconnect the cartridge housing module at the quick connect following the pressure gauge (the insertion point shown in **Figure VIII-1**), if connected, and cover the open ends leading into the modules with sterile foil.

Step 3. Remove the foil from the ends of the discharge module and from the free end of the regulator module. Connect the discharge module to the regulator module. Place the control flow valve or tubing connected to the outlet of the flow control valve into a one liter plastic bottle. Note that the injector module, the prefilter module and the cartridge housing module must not be attached to the apparatus at this stage of the procedure!

Step 4. Slowly turn on the tap and adjust the pressure regulator until the pressure gauge on the regulator module reads 30 PSI. If the tap is incapable of 30 PSI, adjust the regulator to achieve the maximum pressure. Pressures less than 30 PSI will result in a reduced flow rate and thus longer sampling times. Flush the apparatus assembly with at least 20 gal of the water to be sampled. While the system is being flushed, measure the pH, the temperature and the turbidity on the water collecting in and overflowing from the one liter plastic bottle. Record the values onto the **Sample Data Sheet** (see **Part 9**).

*The pH meter should be calibrated before each use for the pH range of the water to be sampled.*

*The turbidity reading may be taken from an in-line turbidimeter connected to the tap being used.*

Step 5. If the sample has a pH above 8.0 **or** contains a disinfectant, turn off the water at the tap and disconnect the discharge module from the regulator module. Remove the foil from the

ends of a single injector module (see **Figure VIII-2**) and connect the module to the male quick connect of the regulator module. Reattach the discharge module.

Step 6. If the sample has a pH above 8.0 **and** contains a disinfectant, turn off the water at the tap and disconnect the discharge module from the regulator module. Remove the foil from the ends of a double injector module (see **Figure VIII-2**) and connect the module to the male quick connect of the regulator module. Reattach the discharge module.

Step 7. If an injector module has been added, remove the foil from the injector port(s) and attach the injector tubing to each port. Add a hosecock clamp to each injector tubing and tighten completely to prevent flow into the injector(s). Turn the fine metering adjustment screw on each injector (the smaller screw) clockwise as far as it will go to minimize the flow rate until the injectors are adjusted (note that the injectors were designed to have a minimum flow rate of 20-30 mL/min; thus completely closing the fine metering adjustment screw does not stop the flow). Place the other end of each tubing into the appropriate sterile graduated container containing 0.1 M HCl or 2% thiosulfate. Take care not to touch or contaminate the surfaces of the injector tubing that will be placed in the graduated containers. Slowly turn on the tap again and readjust the pressure regulator, if necessary.

Step 8. If a single injector module has been added, continue to flush the apparatus and adjust the water bypass screw on the injector (the larger adjustment screw) until the pressure gauge on the injector module is about 35% less than the pressure gauge on the regulator module (e.g., 19 PSI when the gauge on the regulator module reads 30 PSI; a minimum of a 35% pressure drop is required to achieve suction). Loosen the hosecock clamp and observe whether suction is occurring. If not, slowly increase the pressure drop until suction starts.

a. If the pH value of the water sample is greater than 8.0, ensure that the injector tubing is placed into a graduated container containing 0.1 M HCl. While continuing to measure the pH in the one liter plastic bottle, adjust the fine metering adjustment screw on the injector to add sufficient HCl to give a pH of 6.5 to 7.5. It may be necessary to use the hosecock clamp to reduce the flow rate to less than 20-30 mL/min or to use a more dilute or concentrated HCl solution with some water samples. When the pH stabilizes at a pH of 6.5 to 7.5, continue with Step 10. Record the adjusted pH onto the **Sample Data Sheet**.

b. If the water to be sampled contains a disinfectant, ensure that the injector tubing is placed into a graduated container containing 2% thiosulfate. Adjust the fine metering adjustment screw on the injector to add thiosulfate at a rate of 10 mL/gal (2.6 mL/L or 30 mL/min at a flow rate of 3 gal/min; note that at this rate, approximately 3-4 L of thio-sulfate solution will be required per sample). When the proper rate is achieved, record the addition of thiosulfate on the **Sample Data Sheet** and continue with Step 10.

Step 9. If a double injector module is being used, continue to flush the apparatus and turn the water bypass screws on each injector clockwise as far as possible. Then turn the water

bypass screws on each regulator one half turn counter clockwise. Continue turning the screws evenly one half turn counter clockwise until the pressure gauge on the double injector module is 35% less than the pressure gauge on the regulator module. Ensure that the tubing from one injector is placed into a graduated container containing 0.1 M HCl and the other into a graduated container containing 2% sodium thiosulfate. Loosen the hosecock clamps. Since there may be slight differences between the injectors and since the pressure reading after the injectors reflects an average pressure drop from both injectors, some additional adjustment of the water bypass screws may be required to obtain suction on each injector. After confirming that each injector is drawing fluid, adjust the flow of HCl and thiosulfate as in Step 8a-8b above. Record the final pH and the addition of thiosulfate on the **Sample Data Sheet** and continue with Step 10.

Step 10. After adjusting the injectors, if required, and flushing the system with at least 20 gal, turn off the flow of water at the sample tap and remove the discharge module. If the water sample has a turbidity greater than 75 NTU, remove the foil from each end of the prefilter module and connect the prefilter module (see **Figure VIII-2**) to the end of the regulator module or to the end of one of the injector modules, if used. Remove the foil from the cartridge housing module and connect it to the end of the regulator module, or to the end of the injector module or the prefilter module, if used. Connect the discharge module to the cartridge housing module.

Step 11. Record the sample number, location, date, time of day and initial gallon (or cubic feet) reading from the water meter onto the **Sample Data Sheet**.

*Use the unique utility-specific sample numbers assigned by the ICR Joint Application Design database.*

Step 12. Slowly turn on the water with the filter housing placed in an upright position, while pushing the red vent button on top of the filter housing to expel air. When the air is totally expelled from the housing, release the button, and open the sample tap completely. Readjust to 30 PSI, if necessary. Check the thiosulfate usage rate or the pH of the discharged water if an injector(s) is being used and readjust, if necessary.

Step 13. Sample a minimum volume for source water of 200 L (7.1 ft<sup>3</sup>, 52.8 gal) and for finished water of 1500 L (53.0 ft<sup>3</sup>, 396.3 gal). Samples for source and finished waters must not exceed 300 L (10.6 ft<sup>3</sup>, 79.3 gal) and 1800 L (63.6 ft<sup>3</sup>, 475.5 gal), respectively. For source water the total amount of sample that can be passed through a filter will depend upon water quality, however, it should be possible to obtain the minimum volume using the procedures described above.

*Samples should be monitored periodically during the sampling. If the filter clogs, contact the approved analyst for further instructions. Since the flow rate may change during sampling due to filter clogging, thiosulfate addition and the adjusted pH of the sample must be checked regularly.*

Step 14. Turn off the flow of water at the sample tap at the end of the sampling period and record the date, time of day, and final gallon (or cubic feet) reading from the water meter onto the **Sample Data Sheet**. Although the final water meter reading may be affected by the addition of HCl and/or thiosulfate, the effect is considered insignificant and may be ignored.

Step 15. Loosen the swivel female insert on the regulator module and disconnect the backflow regulator from the tap. Disconnect the cartridge housing module and the prefilter housing module, if used from the other modules. Turn the filter housing(s) upside down and allow excess water to flow out as waste water. Turn the housing(s) upright and cover the quick connects on each end of the modules with sterile aluminum foil.

Step 16. Pack the cartridge housing module(s) into an insulated shipping box. Add 6-8 small ice packs (prefrozen at  $-20^{\circ}\text{C}$ ) around the cartridge housings to keep the sample cool in transit (the number of ice packs may have to be adjusted based upon experience to ensure that the samples remain cold, but not frozen). Drain and add the regulator and injector modules used. Place the **Sample Data Sheet** (protected with a closable plastic bag) in with the sample and ship by overnight courier to the contracted, approved laboratory for virus analysis. Notify the laboratory by phone upon the shipment of sample.

*The approved laboratory will elute virus from the IMDS filter (and prefilter, if appropriate) and analyze the eluates as described in **Parts 2-3**. After removing the filter, the laboratory will clean, sterilize the apparatus components with chlorine and dechlorinate with sodium thiosulfate as described in **Part 5**. After flushing with sterile  $\text{dH}_2\text{O}$ , a new IMDS cartridge (and prefilter, if appropriate) will be added, the openings sealed with sterile aluminum foil, and the apparatus returned to the utility for the next sample. The discharge module can be stored at the utility between samplings. Openings should be covered with aluminum foil during storage.*

## PART 2 — SAMPLE PROCESSING

### QUALITY CONTROL AND PERFORMANCE EVALUATION SAMPLES

*Quality control (QC) and performance evaluation (PE) samples will be shipped to analysts seeking approval (see Sections III-IV). PE samples must be successfully analyzed by each analyst participating in the ICR virus monitoring program as part of the initial approval process. After initial approval, each analyst must successfully analyze one QC sample set per sample batch and one PE sample set every month. A QC sample set is comprised of a negative and a positive QC sample. A sample batch consists of all the ICR samples that are analyzed by an analyst during a single week. Each sample batch and its associated QC sample set must be assigned a unique batch number. QC samples do not have to be processed during weekly periods when no ICR samples are processed. QC and PE data should be sent directly to the U.S. EPA as specified in Section III.*

#### **QC Samples:**

1. Negative QC Sample: Place a sterile 1MDS filter into a standard filter apparatus.  
*Process and analyze the 1MDS filter using the **Elution, Organic Flocculation and Total Culturable Virus Assay** procedures given below.*
2. Positive QC Sample: Place 40 L of dH<sub>2</sub>O into a sterile polypropylene container (Cole-Parmer Product No. G-06063-32) and add 1 mL of a QC stock of attenuated poliovirus containing 200 PFU/mL<sup>2</sup>. Mix and pump the water through a standard filter apparatus containing a 1MDS filter.  
*Process and analyze the 1MDS filter using the **Elution, Organic Flocculation and Total Culturable Virus Assay** procedures given below.*

#### **PE Samples:**

*Process and analyze PE samples according to the **Elution, Organic Flocculation and Total Culturable Virus Assay** procedures of this protocol and according to any additional procedures supplied with the samples.*

---

<sup>2</sup>A QC sample with a titer of 200 PFU/mL will be supplied for the QC tests described in this Section. The titer of this QC sample may be changed before the start or during the testing phase of the ICR. Analysts must use these samples as supplied and not attempt to adjust the titer to 200 PFU/mL. A high titer QC sample will also be shipped to each analyst so that laboratories can develop their own internal QC programs. The high titered sample is not to be used for the QC tests described in this Section.



## ELUTION PROCEDURE

*The cartridge filters must arrive from the utility in a refrigerated, but not frozen, condition. The arrival condition should be recorded on the **Sample Data Sheet (Part 9)**. Filters should be refrigerated upon arrival and eluted within 72 h of the start of the sample collection.*

### **Apparatus and Materials:**

1. Positive pressure air or nitrogen source equipped with a pressure gauge.  
*If the pressure source is a laboratory air line or pump, it must be equipped with an oil filter.*
2. Dispensing pressure vessels — 5 or 20 liter capacity (Millipore Corp. Product No. XX67 00P 05 and XX67 00P 20).
3. pH meter with combination-type electrode and an accuracy of at least 0.1 pH unit.
4. Autoclavable inner-braided tubing with screw clamps or quick connects for connecting tubing to equipment.
5. Magnetic stirrer and stir bars.

### **Media and Reagents:**

1. Sodium hydroxide (NaOH) — prepare 1 M and 5 M solutions by dissolving 4 g or 20 g of NaOH in a final volume of 100 mL of dH<sub>2</sub>O, respectively.

*NaOH solutions may be stored for several months at room temperature.*

2. Beef extract V powder (BBL Microbiology Systems Product No. 97531) — prepare buffered 1.5% beef extract by dissolving 30 g of beef extract powder and 7.5 g of glycine (final glycine concentration = 0.05 M) in 1.9 L of dH<sub>2</sub>O. Adjust the pH to 9.5 with 1 or 5 M NaOH and bring the final volume to 2 L with dH<sub>2</sub>O. Autoclave at 121 °C for 15 min and use at room temperature.

*Beef extract solutions may be stored for one week at 4 °C or for longer periods at -20 °C.*

*Screen each new lot of beef extract before use in the **Organic Flocculation Concentration Procedure** to determine whether virus recoveries are adequate. Perform the screening by spiking one liter of beef extract solution with 1 mL of a diluted QC sample containing 200 PFU/mL. Assay the spiked sample according to the **Organic Flocculation and Total Culturable Virus Assay** procedures given below. Use a single passage with undiluted sample and sample diluted 1:5 and 1:25 along with an equivalent positive control. The mean recovery of poliovirus for three trials should be at least 50%.*

**Procedure:**

*Place a disinfectant-soaked sponge over vents while releasing trapped air or pressure throughout this procedure to minimize dangers from aerosols.*

Step 1. Attach sections of braided tubing (sterilized on inside and outside surfaces with chlorine and dechlorinated with thiosulfate as described in **Part 5**) to the inlet and outlet ports of a cartridge housing module containing a 1MDS filter to be tested for viruses. If a prefilter was used, keep the prefilter and cartridge housing modules connected and attach the tubing to the inlet of the prefilter module and to the outlet of the cartridge housing module.

Step 2. Place the sterile end of the tubing connected to the outlet of the cartridge housing module into a sterile two liter glass or polypropylene beaker.

Step 3. Connect the free end of the tubing from the inlet port of the prefilter or cartridge housing modules to the outlet port of a sterile pressure vessel and connect the inlet port of the pressure vessel to a positive air pressure source. Add pressure to blow out any residual water from the cartridge housing(s). Open the vent/relief valve to release the pressure.

Step 4. Remove the top of the pressure vessel and pour 1000 mL of buffered 1.5% beef extract (pH 9.5, prewarmed to room temperature) into the vessel. Replace the top of the pressure vessel and close its vent/relief valve.

*Acceptable alternatives to the use of a pressure vessel include 1) the use of a peristaltic pump and sterile tubing to push the beef extract through the filter and 2) the addition of beef extract directly to the cartridge housing and the use of positive pressure to push the beef extract through the filter.*

Step 5. Open the vent/relief valve(s) on the cartridge housing(s) and slowly apply sufficient pressure to purge trapped air from them. Close the vent/relief valve(s) as soon as the buffered beef extract solution begins to flow from it. Turn off the pressure and allow the solution to contact the 1MDS filter for 1 min.

*Wipe up spilled liquid with disinfectant-soaked sponge. Carefully observe alternative housings without vents to ensure that all trapped air has been purged.*

Step 6. Increase the pressure to force the buffered beef extract solution through the filter(s).

*The solution should pass through the 1MDS filter slowly to maximize the elution contact period. When air enters the line from the pressure vessel, elevate and invert the filter housing to permit complete evacuation of the solution from the filters.*

Step 7. Turn off the pressure at the source and open the vent/relief valve on the pressure vessel. Place the buffered beef extract from the two liter beaker back into the pressure vessel. Replace the top of the pressure vessel and close its vent/relief valve. Repeat Steps 5 - 6.

Step 8. Turn off the pressure at the source and open the vent/relief valve on the pressure vessel. Thoroughly mix the eluate. Adjust the pH of the eluate to 7.0-7.5 with 1 M HCl. If archiving is not required and if the optional coliphage assay is not performed, measure the volume of the eluate and record it onto the **Virus Data Sheet** as the **Eluate Volume Recovered**. Transfer the **Total Sample Volume** from the **Sample Data Sheet** to the **Adjusted Total Sample Volume** on the **Virus Data Sheet**.

Step 9. If archiving is required or if the optional coliphage assay (see **Section IX. Coliphage Assay**) will be performed, adjust the pH of the eluate to 7.0-7.5 with 1 M HCl. Measure the volume of the adjusted eluate and record it onto the **Virus Data Sheet** as the **Eluate Volume Recovered**. Determine the amount of sample to be used in the coliphage assay by multiplying the **Eluate Volume Recovered** by 0.035. Place a volume equal to the product obtained into a separate container and store at 4°C. If archiving is not required, multiply the **Total Sample Volume** from the **Sample Data Sheet** by 0.965 and record the product as the **Adjusted Total Sample Volume** on the **Virus Data Sheet**.

Step 10. If archiving is required, determine the amount of sample to remove for archiving by multiplying the **Eluate Volume Recovered** by 0.1. Record the product onto the **Virus Data Sheet** as the **Volume of Eluate Archived** and place this volume into a separate container. Freeze<sup>3</sup> the archive sample and ship it to the ICR Laboratory Coordinator, USEPA, TSD, 26 W. Martin Luther King Drive, Cincinnati, OH 45268. Multiply the **Total Sample Volume** from the **Sample Data Sheet** by 0.865 if the optional coliphage assay is performed or by 0.9 if the sample was not assayed for coliphage. Record the product as the **Adjusted Total Sample Volume** on the **Virus Data Sheet**.

Step 11. Proceed to the **Organic Flocculation Concentration Procedure** immediately. If the **Organic Flocculation Concentration Procedure** cannot be undertaken immediately, store the eluate (adjusted to pH 7.0 to 7.5 as described in Step 8b) at 4°C for up to 24 h or for longer periods at -70°C.

#### ORGANIC FLOCCULATION CONCENTRATION PROCEDURE

##### **Apparatus and Materials:**

1. Refrigerated centrifuge capable of attaining 2,500 - 10,000 ×g and screw-capped centrifuge bottles with 100 to 1000 mL capacity.

---

<sup>3</sup>All freezing of samples and cell cultures throughout this protocol should be performed rapidly by placing vessels in a freezer at -70°C or below or in a dry ice-alcohol bath. Frozen samples and cell cultures should also be thawed rapidly. This may be done by placing vessels in a 37°C waterbath, but vessel caps must not be immersed and vessels should be removed from the waterbath as soon as or just before the last ice crystals melt.

*Each bottle must be rated for the relative centrifugal force used.*

2. Sterilizing filter — 0.22  $\mu\text{m}$  Acrodisc filter with prefilter (Gelman Sciences Product No. 4525).

*Use sterilizing filter stacks on samples that clog commercial filters. Prepare sterilizing filter stacks using 0.22  $\mu\text{m}$  pore size membrane filters (Millipore Corp. Product No. GSWP 47 00) stacked with fiberglass prefilters (Millipore Corp. AP15 47 00 and AP20 47 00).*

*Stack the prefilters and 0.22  $\mu\text{m}$  membrane into a disc filter holder (Millipore Corp. Product No. SX00 47 00) with the AP20 prefilter on top and 0.22  $\mu\text{m}$  membrane filter on bottom. Disassemble the filter stack after each use to check the integrity of the 0.22  $\mu\text{m}$  filter. Refilter any media filtered with a damaged stack.*

*Always pass about 10 - 20 mL of sterile beef extract, pH 7.0-7.5 (prepared as above, without pH adjustment), through the filter just before use. This step will reduce virus adsorption onto the filter membranes.*

### **Media and Reagents:**

1. Sodium phosphate, dibasic ( $\text{Na}_2\text{HPO}_4 \cdot 7\text{H}_2\text{O}$ ) — 0.15 M, pH 9.0 - 9.5 or 7.0 - 7.5.

*Dissolve 40.2 g of sodium phosphate in a final volume of 1000 mL  $\text{dH}_2\text{O}$ . The pH of the solution should be between 9.0 - 9.5. Adjust the pH to 9.0 to 9.5 with NaOH, if necessary, or to 7.0 to 7.5 with HCl. Autoclave at 121  $^\circ\text{C}$  for 15 min.*

### **Procedure:**

*Minimize foaming (which may inactivate viruses) throughout the procedure by not stirring or mixing faster than necessary to develop a vortex.*

Step 1. Place a sterile stir bar into the beaker containing the buffered beef extract eluate from the cartridge filter(s). Place the beaker onto a magnetic stirrer, and stir at a speed sufficient to develop a vortex.

Step 2. Insert a combination-type pH electrode into the beef extract eluate. Add 1 M HCl to the eluate slowly while moving the tip of the pipette in a circular motion away from the vortex to facilitate mixing. Continue adding 1 M HCl until the pH reaches  $3.5 \pm 0.1$  and then stir slowly for 30 min at room temperature.

*The pH meter must be standardized at pH 4 and 7. Electrodes must be sterilized before and after each use as described in **Part 5**.*

*A precipitate will form. If pH falls below 3.4, add 1 M NaOH to bring it back to  $3.5 \pm 0.1$ . Exposure to a pH below 3.4 may result in some virus inactivation.*

Step 3. Remove the electrode from the beaker, and pour the contents of the beaker into a centrifuge bottle. Cap the bottle and centrifuge the precipitated beef extract suspension at  $2,500 \times g$  for 15 min at  $4^\circ\text{C}$ . Remove and discard the supernatant.

*To prevent the transfer of the stir bar into a centrifuge bottle, hold another stir bar or magnet against the bottom of the beaker while decanting the contents. The beef extract suspension will usually have to be divided into several centrifuge bottles.*

Step 4. Place a stir bar into the centrifuge bottle that contains the precipitate. Add 30 mL of 0.15 M sodium phosphate, pH 9.0 - 9.5. Place the bottle onto a magnetic stirrer, and stir slowly until the precipitate has dissolved completely.

*Since the precipitate may be difficult to dissolve, it can be partially dispersed with a spatula before or during the stirring procedure. It may also be dissolved by repeated pipetting or by shaking at 160 rpm for 20 min on an orbital shaker in place of stirring. When the centrifugation is performed in more than one bottle, dissolve the precipitates in a total of 30 mL and combine into one bottle. If the precipitate is not completely dissolved before proceeding, significant virus loss may occur in Step 5. Because virus loss may also occur by prolonged exposure to pH 9.0-9.5, laboratories that find it difficult to resuspend the precipitate may dissolve it initially in 0.15 M sodium phosphate, pH 7.0 - 7.5. If this variation is used, the pH should be re-adjusted to 9.0-9.5 with 1 M NaOH after the precipitate is completely dissolved and mixed for 10 min at room temperature before proceeding to Step 5.*

Step 5. Check the pH and readjust to 9.0-9.5 with 1 M NaOH, as necessary. Remove the stir bar and centrifuge the dissolved precipitate at 4,000 - 10,000 ×g for 10 min at 4°C. Remove the supernatant and discard the pellet. Adjust the pH of the supernatant to 7.0-7.5 with 1 M HCl. To remove microbial contamination, load the supernatant into a 50 mL syringe and force it through a sterilizing filter pretreated with beef extract (laboratories may use other approaches to remove contamination, but their effectiveness must be documented). Record the final supernatant (designated the **Final Concentrated Sample Volume ; FCSV**) on the **Virus Data Sheet** (see **Part 9**).

*If the sterilizing filter begins to clog badly, empty the loaded syringe into the bottle containing the unfiltered supernatant, fill the syringe with air, and inject air into filter to force any residual sample from it. Continue the filtration procedure with another filter.*

Step 6. Determine the volume of sample that must be assayed. This volume is at least 100 L for source water or 1000 L for finished water and is designated the **Volume of Original Water Sample Assayed<sup>4</sup> (D)**. Record the value of **D** on the **Virus Data Sheet**. Calculate the **Assay Sample Volume (S)** for source and finished water samples using the formula:

$$S = \frac{D}{ATSV} \times FCSV$$

---

<sup>4</sup>Analytical laboratories assaying more than the required volume must use the actual volume to be assayed in the calculation. See **Part 8** for examples of the calculations used in this protocol.

where **ATSV** is the **Adjusted Total Sample Volume** from the **Virus Data Sheet**. The **Assay Sample Volume** is the volume of the **Final Concentrated Sample** that represents 100 L of source water or 1000 L of finished water. Record the **Assay Sample Volume** onto the **Virus Data Sheet**. Prepare a subsample (subsample 1) containing a volume 0.55 times the **Assay Sample Volume**. Prepare a second subsample (subsample 2) containing a volume that is 0.67 times the **Assay Sample Volume**. Divide the **Final Concentrated Sample** from QC and PE samples into two equal subsamples. Calculate the **Assay Sample Volume** for these samples by multiplying **FCSV** by 0.4. Label each subsample with appropriate sampling information for identification. Hold any portion of the sample that can be assayed within 24 h at 4 °C and freeze all other portions at -70 °C.

*Final Concentrated Samples, subsamples, PE and QC samples processed to this point by a laboratory not doing the virus assay must be frozen at -70 °C immediately and then shipped on dry ice to the laboratory approved for the virus assay.*

## PART 3 — TOTAL CULTURABLE VIRUS ASSAY

### QUANTAL ASSAY

#### **Apparatus and Materials:**

1. Incubator capable of maintaining the temperature of cell cultures at  $36.5 \pm 1^\circ\text{C}$ .
2. Sterilizing filter —  $0.22 \mu\text{m}$  (Costar Product No. 140666).  
*Always pass about 10 - 20 mL of 1.5% beef extract, pH 7.0-7.5, through the filter just before use to minimize virus adsorption to the filter.*

#### **Media and Reagents:**

1. Prepare BGM cell culture test vessels using standard procedures.  
*BGM cells are a continuous cell line derived from African Green monkey kidney cells and are highly susceptible to many enteric viruses (Dahling et al., 1984; Dahling and Wright, 1986). The characteristics of this line were described by Barron et al. (1970). The use of BGM cells for recovering viruses from environmental samples was described by Dahling et al. (1974). For laboratories with no experience with virus recovery from environmental samples, the media and procedures described by Dahling and Wright (1986) and given in **Part 4** are recommended for maximum sensitivity.*  
*EPA will supply an initial culture of BGM cells at about passage 117 to all laboratories seeking approval. Upon receipt, laboratories must prepare an adequate supply of frozen BGM cells using standard procedures to replace working cultures that become contaminated or lose virus sensitivity. A **Procedure for Preservation of the BGM Cell Line** is given in **Part 4**. Only BGM cells from the U.S. EPA and between passage 117 and 250 may be used for virus monitoring under the ICR.*

#### **Sample Inoculation and CPE Development:**

*Cell cultures used for virus assay are generally found to be at their most sensitive level between the third and sixth days after their most recent passage. Those older than seven days should not be used.*

Step 1. Identify cell culture test vessels by coding them with an indelible marker. Return the cell culture test vessels to a  $36.5 \pm 1^\circ\text{C}$  incubator and hold at that temperature until the cell monolayer is to be inoculated.

Step 2. Decant and discard the medium from cell culture test vessels. Wash the test vessels with a balanced salt solution or maintenance medium without serum using a wash volume of at least  $0.06 \text{ mL/cm}^2$  of surface area. Rock the wash medium over the surface of each monolayer several times and then decant and discard the wash medium.

*Do not disturb the cell monolayer.*

Step 3. Determine the **Inoculum Volume** by dividing the **Assay Sample Volume** by 20. Record the **Inoculum Volume** onto the **Virus Data Sheet**. The **Inoculum Volume** should be no greater than 0.04 mL/cm<sup>2</sup> of surface area. If the **Inoculum Volume** is greater than 0.04 mL/cm<sup>2</sup>, use larger culture vessels.

Step 4. Inoculate each BGM cell culture test vessel with an amount of assay control or water sample equal to the **Inoculum Volume** and record the date of inoculation on the **Sample Data Sheet** (see **Part 9**).

*Avoid touching either the cannula or the pipetting device to the inside rim of the cell culture test vessels to avert the possibility of transporting contaminants to the remaining culture vessels.*

*For ease of inoculation, a sufficient quantity of 0.15 M Na<sub>2</sub>HPO<sub>4</sub>, pH 7.0 - 7.5, may be added to the **Inoculum Volume** to give a more usable working **Inoculation Volume** (e.g., 1.0 mL). For example, if an **Inoculum Volume** of 0.73 mL is to be placed onto 10 vessels, then  $10.5 \times (1 - 0.73 \text{ mL}) = 2.84 \text{ mL}$  of sodium phosphate, pH 7.0-7.5 could be added to  $10.5 \times 0.73 = 7.67 \text{ mL}$  of subsample. Each milliliter of the resulting mixture will contain the required **Inoculum Volume**.*

a. Total Culturable Virus Assay Controls:

*Run a negative and positive assay control with every group of subsamples inoculated onto cell cultures.*

- i. **Negative Assay Control:** Inoculate a BGM culture with a volume of sodium phosphate, pH 7.0 - 7.5, equal to the **Inoculation Volume**. This culture will serve as negative control for the tissue culture quantal assay. If any **Negative Assay Control** develops cytopathic effects (CPE), all subsequent assays of water samples should be halted until the cause of the positive result is determined.
- ii. **Positive Assay Control:** Dilute attenuated poliovirus type 3 (from the high titered QC stock) in sodium phosphate, pH 7.0 - 7.5, to give a concentration of 20 PFU per **Inoculation Volume**. Inoculate a BGM culture with an amount of diluted virus equal to the **Inoculation Volume**. This control will provide a measure for continued sensitivity of the cell cultures to virus infection. Additional positive control samples may be prepared by adding virus to a small portion of the final concentrated sample and/or by using additional virus types. If any **Positive Assay Control** fails to develop CPE, all subsequent assays of water samples should be halted until the cause of the negative result is determined. It may be necessary to thaw and use an earlier passage of the BGM cell line supplied by the U.S. EPA.



b. Inoculation of Water Samples

- i. Rapidly thaw subsample 1, if frozen, and inoculate an amount equal to the **Inoculum Volume** onto each of 10 cell cultures. If there is no evidence for cytotoxicity and if at least three cell cultures are negative for CPE after seven days (see below), thaw subsample 2 and inoculate an amount equal to the **Inoculum Volume** onto each of 10 additional cultures.

*Hold a thawed subsample for no more than 4 h at 4 °C. Warm the subsample to room temperature just before inoculation.*

*A small portion of the Final Concentrated Sample may be inoculated onto cultures several days before inoculating subsample 1 as a control for cytotoxicity.*

- ii. If cytotoxicity is not a problem and more than seven cultures are positive for CPE after seven days, prepare five- and twenty five-fold dilutions of subsample 2. To prepare a 1:5 dilution, add a volume equal to 0.1334 times the **Assay Sample Volume** (amount "a") to a volume of 0.15 M sodium phosphate (pH 7.0-7.5) equal to 0.5334 times the **Assay Sample Volume** (amount "b"). After mixing thoroughly, prepare a 1:25 dilution by adding amount "a" of the 1:5 diluted sample to amount "b" of 0.15 M sodium phosphate (pH 7.0-7.5). Using an amount equal to the **Inoculum Volume**, inoculate 10 cell cultures each with undiluted subsample 2, subsample 2 diluted 1:5 and subsample 2 diluted 1:25, respectively. Freeze the remaining portions of the 1:25 dilution at -70°C until the sample results are known. If the inoculated cultures are all positive, thaw the remaining 1:25 dilution and prepare 1:125, 1:625 and 1:3125 dilutions by transferring amount "a" of each lower dilution to amount "b" of sodium phosphate as described above. Inoculate 10 cultures each with the additional dilutions and freeze the remaining portion of the 1:3125 dilution. Continue the process of assaying higher dilutions until at least one test vessel at the highest dilution tested is negative. Higher dilutions can also be assayed along with the initial undiluted to 1:25 dilutions if it is suspected that the water to be tested contains more than 500 most probable number (MPN) of infectious total culturable virus units per 100 L.
- iii. If subsample 1 is cytotoxic, then five cell cultures should be inoculated with Final Concentrated Sample using the same volume required for subsample 1 and the procedures described in the **Reduction of Cytotoxicity in Sample Concentrates** section below. If these procedures remove cytotoxicity, inoculate subsample 2 using the procedures for removal of cytotoxicity and 10 cultures each with undiluted sample, sample diluted 1:5 and sample diluted 1:25 as in Step 4bii above. If the procedures fail to remove cytotoxicity, write for advice on how to proceed to the ICR Laboratory Coordinator, U.S. EPA, Office of Ground Water and Drinking Water, Technical Support Division, 26 W. Martin Luther King Drive, Cincinnati, OH 45268.

*A maximum of 60 and 580 MPN units per 100 L can be demonstrated by inoculating a total of 20 cultures with the undiluted Assay Sample Volume from source water or a total of 10 cultures each with undiluted sample and sample diluted 1:5 and 1:25, respectively.*

c. Inoculation of QC and PE Samples: prepare five-fold dilutions of subsample 1 for each negative QC sample as described in Step 4bii. Prepare five- and twenty five-fold dilutions for each positive QC and PE sample. Inoculate 10 cultures with undiluted subsample and each diluted subsample using an amount of inoculum equal to the **Inoculum Volume**.

*Use subsample 2 only as a backup for problems with the analysis of subsample 1.*

Step 5. Rock the inoculated cell culture test vessels gently to achieve uniform distribution of inoculum over the surface of the cell monolayers. Place the cell culture test vessels on a level stationary surface at room temperature so that the inoculum remains distributed evenly over the cell monolayer.

Step 6. Continue incubating the inoculated cell cultures for 80 - 120 min to permit viruses to adsorb onto and infect cells.

*It may be necessary to rock the vessels every 15-20 min or to keep them on a mechanical rocking platform during the adsorption period to prevent cell death in the middle of the vessels from dehydration.*

Step 7. Add liquid maintenance medium (see Item 2 of **Vessels and Media for Cell Growth in Part 4** for recommended medium) and incubate at  $36.5 \pm 1^\circ\text{C}$ .

*Warm the maintenance medium to  $36.5 \pm 1^\circ\text{C}$  before placing it onto cell monolayers. Add the medium to the side of the cell culture vessel opposite the cell monolayer. Avoid touching any pipetting devices used to the inside rim of the culture vessels to avert the possibility of transporting contaminants to the remaining vessels. The cultures may be re-fed with fresh maintenance medium after 4 - 7 days.*

Step 8. Examine each culture microscopically for the appearance of CPE daily for the first three days and then every couple of days for a total of 14 days.

*CPE may be identified as cell disintegration or as changes in cell morphology. Rounding-up of infected cells is a typical effect seen with enterovirus infections. However, uninfected cells round-up during mitosis and a sample should not be considered positive unless there are significant clusters of rounded-up cells over and beyond what is observed in the uninfected controls. Photomicrographs demonstrating CPE appear in the reference by Malherbe and Strickland-Cholmley (1980).*

Step 9. Freeze cultures at  $-70^\circ\text{C}$  when more than 75% of the monolayer shows signs of CPE. Freeze all remaining negative cultures, including controls, after 14 days.

Step 10. Thaw all the cultures to confirm the results of the previous passage. Filter at least 10% of the medium from each vessel that was positive for CPE or that appeared to be bacterially contaminated through separate 0.22 µm sterilizing filters. Then inoculate another BGM culture with 10% of the medium from the previous passage for each vessel, including those that were negative. Repeat Steps 7 - 8.

*Confirmation passages may be performed in small vessels or multiwell trays, however, it may be necessary to distribute the inoculum into several vessels or wells to insure that the **Inoculum Volume** is less than or equal to 0.04 mL/cm<sup>2</sup> of surface area.*

Step 11. Score cultures that developed CPE in both the first and second passages as confirmed positives. Cultures that show CPE in only the second passage must be passaged a third time along with the negative controls according to Steps 9 - 10. Score cultures that develop CPE in both the second and third passages as confirmed positives.

*Cultures with confirmed CPE may be stored in a -70 °C freezer for research purposes or for optional identification tests.<sup>5</sup>*

### **Virus Quantitation:**

Step 1. Record the total number of confirmed positive and negative cultures for each subsample onto the **Total Culturable Virus Data Sheet (Part 9)**. Do not include the results of tests for cytotoxicity!

Step 2. Transfer the number of cultures inoculated and the confirmed number of positive cultures from the **Total Culturable Virus Data Sheet** for each subsample to the **Quantitation of Total Culturable Virus Data Sheet**. If dilutions are not required, add the values to obtain a total undiluted count for each sample. Calculate the MPN/mL value ( $M_m$ ) and the upper ( $CL_{um}$ ) and lower ( $CL_{lm}$ ) 95% confidence limits using the total undiluted count. If dilutions are required, calculate the MPN/mL value and 95% confidence limits using only the subsample 2 values. Place the values obtained onto the **Quantitation of Total Culturable Virus Data Sheet**. The MPNV computer program supplied by the U.S. EPA must be used for the calculation of all MPN values and confidence limits.

Step 3. Calculate the MPN per 100 liter value ( $M_l$ ) of the original water sample according the formula:

$$M_l = \frac{100 M_m S}{D}$$

---

<sup>5</sup>For more information see Chapter 12 (May 1988 revision) of Berg *et al.* (1984).

where S equals the **Assay Sample Volume** and D equals the **Volume of Original Water Sample Assayed** (the values for S and D can be found on the **Virus Data Sheet**). Record the value of  $M_1$  onto the **Virus Data Sheet**.<sup>6</sup>

Step 4. Calculate the lower 95% confidence limit per 100 liter value ( $CL_l$ ) for each water sample according to the formula:

$$CL_l = \frac{100 CL_{lm} S}{D}$$

where  $CL_{lm}$  is the lower 95% confidence limit per milliliter from the **Quantitation of Total Culturable Virus Data Sheet**. Calculate the upper 95% Confidence Limit per 100 liter value ( $CL_u$ ) according to the formula:

$$CL_u = \frac{100 CL_{um} S}{D}$$

where  $CL_{um}$  is the upper 95% confidence limit per milliliter from the **Quantitation of Total Culturable Virus Data Sheet**. Record the limit per 100 liter values on the **Virus Data Sheet**.

Step 5. Calculate the total MPN value and the total 95% confidence limit values for each QC and PE sample by multiplying the values per milliliter by S and dividing by 0.4.

#### REDUCTION OF CYTOTOXICITY IN SAMPLE CONCENTRATES

*The procedure described in this section may result in a significant titer reduction and should be applied only to inocula known to be or expected to be toxic.*

#### **Media and Reagents:**

##### 1. Washing solution.

*Dissolve 8.5 g of NaCl in a final volume of 980 mL of dH<sub>2</sub>O. Autoclave the solution at 121 °C for 15 min. Cool to room temperature. Add 20 mL serum to the sterile salt solution. Mix thoroughly. Store the washing solution at 4 °C for up to three months or at -20 °C.*

*The volume of the NaCl washing solution required will depend on the number of bottles to be processed and the cell surface area of the vessels used for the quantal assay.*

---

<sup>6</sup>Use significant figures when reporting all results throughout the protocol (see APHA, 1995, p. 1-17).

## **Procedure for Cytotoxicity Reduction:**

Step 1. Decant and save the inoculum from inoculated cell culture vessels after the adsorption period (Step 5 of **Sample Inoculation and CPE Development**). Add 0.25 mL of the washing solution for each cm<sup>2</sup> of cell surface area into each vessel.

*Warm the washing solution to  $36.5 \pm 1$  °C before placing on cell monolayer. Add the washing solution to the side of the cell culture vessel opposite the cell monolayer. Avoid touching any pipetting devices used to the inside rim of the culture vessels to avert the possibility of transporting contaminants to the remaining vessels.*

*The inocula saved after the adsorption period should be stored at -70 °C for subsequent treatment and may be discarded when cytotoxicity is successfully reduced.*

Step 2. Gently rock the washing solution gently across the cell monolayer a minimum of two times. Decant and discard the spent washing solution without disturbing the cell monolayer.

*It may be necessary to rock the washing solution across the monolayer more than twice if sample is oily and difficult to remove from the cell monolayer surface.*

Step 3. Continue with Step 7 of the procedure for **Sample Inoculation and CPE Development**.

*If this procedure fails to reduce cytotoxicity with a particular type of water sample, backup samples may be diluted 1:2 to 1:4 before repeating the procedure. This dilution requires that two to four times more culture vessels be used. Dilution alone may sufficiently reduce cytotoxicity of some samples without washing. Alternatively, the changing of liquid maintenance medium at the first signs of cytotoxicity may prevent further development.*

*Determine cytotoxicity from the initial daily macroscopic examination of the appearance of the cell culture monolayer by comparing the negative control from Step 4ai and the positive control from Step 4aaii of the procedure for **Sample Inoculation and CPE Development** with the test samples from Step 4b). Cytotoxicity should be suspected when the cells in the test sample develop CPE before its development on the positive control.*

## **PART 4 — CELL CULTURE PREPARATION AND MAINTENANCE**

### **PREPARATION OF CELL CULTURE MEDIUM**

#### **General Principles:**

1. Equipment care — Carefully wash and sterilize equipment used for preparing media before each use.
2. Disinfection of work area — Thoroughly disinfect surfaces on which the medium preparation equipment is to be placed.
3. Aseptic technique — Use aseptic technique when preparing and handling media or medium components.
4. Dispensing filter-sterilized media — To avoid post-filtration contamination, dispense filter-sterilized media into storage containers through clear glass filling bells in a microbiological laminar flow hood. If a hood is unavailable, use an area restricted solely to cell culture manipulations.
5. Coding media — Assign a lot number to and keep a record of each batch of medium or medium components prepared. Place the lot number, the date of preparation, the expiration date, and the initials of the person preparing the medium on each bottle.
6. Sterilization of  $\text{NaHCO}_3$ -containing solutions — Sterilize media and other solutions that contain  $\text{NaHCO}_3$  by positive pressure filtration.  
*Negative pressure filtration of such solutions increases the pH and reduces the buffering capacity.*
7. Antibiotic solutions prepared in-house must be filter sterilized with 0.22  $\mu\text{m}$  membrane filters. It is important that the recommended antibiotic levels not be exceeded during the planting of cells, as cultures are particularly sensitive to excessive concentrations at this stage. Antibiotic stock solutions should be placed in screw-capped containers and stored at  $-20^\circ\text{C}$  until needed. Once thawed, they may be refrozen; however, repeated freezing and thawing of these stock solutions should be avoided by freezing them in quantities that are sufficient to support a week's cell culture work.

#### **Apparatus and Materials:**

1. Glassware, Pyrex (Corning Product No. 1395).  
*Storage vessels must be equipped with airtight closures.*

2. Disc filter holders — 142 mm or 293 mm diameter (Millipore Product No. YY30 142 36 and YY30 293 16).  
*Use only positive pressure type filter holders.*
3. Sterilizing filter stacks — 0.22  $\mu\text{m}$  pore size (Millipore Product No. GSWP 142 50 and GSWP 293 25). Fiberglass prefilters (Millipore AP15 142 50 or AP15 293 25, and AP20 142 50 or AP20 293 25).  
*Stack AP20 and AP15 prefilters and 0.22  $\mu\text{m}$  membrane filter into a disc filter holder with AP20 prefilter on top and 0.22  $\mu\text{m}$  membrane filter on bottom.*  
*Always disassemble the filter stack after use to check the integrity of the 0.22  $\mu\text{m}$  filter.*  
*Refilter any media filtered with a damaged stack.*
4. Positively-charged cartridge filter — 10 inch (Zeta plus TSM, Cuno Product No. 45134-01-600P). Cartridge housing with adaptor for 10 inch cartridge (Millipore Product No. YY16 012 00).
5. Culture capsule filter (Gelman Sciences Product No. 12170).
6. Cell culture vessels — Pyrex, soda or flint glass or plastic bottles and flasks or roller bottles (e.g., Brockway Product No. 1076-09A, 1925-02, Corning Product No. 25100-25, 25110-75, 25120-150, 25150-1750).  
*Vessels must be made from clear glass or plastic to allow observation of the cultures and be equipped with airtight closures. Plastic vessels must be treated by the manufacturer to allow cells to adhere properly.*
7. Screw caps, black with rubber liners (Brockway Product No. 24-414).  
*Caps for larger culture bottles usually supplied with bottles.*
8. Roller apparatus (Bellco Glass Product No. 7730).  
*Required only if roller bottles are used for maintenance of stock cultures.*
9. Waterbath set at  $56 \pm 1^\circ\text{C}$ .
10. Light microscope, with conventional light source, equipped with lenses to provide 40X, 100X, and 400X total magnification.
11. Inverted light microscope equipped with lenses to provide 40X, 100X, and 400X total magnification.
12. Phase contrast counting chamber (hemocytometer) (Curtin Matheson Scientific Product No. 158-501).
13. Conical centrifuge tubes — 50 and 250 mL capacity.

14. Rack for tissue culture tubes (Bellco Product No. 2028).
15. Bottles, aspirator-type with tubing outlet — 2,000 mL capacity.  
*Bottles for use with pipetting machine.*
16. Storage vials — 2 mL capacity.  
*Vials must withstand temperatures to -70 °C.*

### **Media and Reagents:**

1. Sterile fetal calf, gamma globulin-free newborn calf or iron-supplemented calf serum, certified free of viruses, bacteriophage and mycoplasma.  
*Test each lot of serum for cell growth and toxicity before purchasing. Serum should be stored at -20 °C for long-term storage. Upon thawing, each bottle must be heat-inactivated in a waterbath set at  $56 \pm 1$  °C for 30 min and stored at 4 °C for short term use.*
2. Trypsin, 1:250 powder (Difco Laboratories Product No. 0152-15-9) or trypsin, 1:300 powder (Becton Dickinson Microbiology Systems Product No. 12098).
3. EDTA (Fisher Scientific Product No. S657-500).
4. Fungizone (amphotericin B, Sigma Product No. A-9528), penicillin G (Sigma Product No. P-3032), streptomycin sulfate (ICN Biomedicals Product No. 100556), tetracycline hydrochloride (ICN Biomedicals Product No. 103011).  
*Use antibiotics of at least tissue culture grade.*
5. Eagle's minimum essential medium (MEM) with Hanks' salts and L-glutamine, without sodium bicarbonate (Life Technologies Product No. 410-1200).
6. Leibovitz's L-15 medium with L-glutamine (Life Technologies Product No. 430-1300).
7. Trypan blue (Sigma Chemical Product No. T-6146).
8. Dimethyl sulfoxide (DMSO; Sigma Chemical Product No. D-2650).

### **Media Preparation Recipes:**

*The conditions specified by the supplier for storage and expiration dates of commercially available media should be strictly observed.*

1. Procedure for the preparation of 10 L of EDTA-trypsin.  
*The procedure described is used to dislodge cells attached to the surface of culture bottles and flasks. This reagent, when stored at 4 °C, retains its working strength for at least four*



months. The amount of reagent prepared should be based on projected usage over a four month period.

Step a. Add 30 g of trypsin (1:250) or 25 g of trypsin (1:300) to 2 L of dH<sub>2</sub>O in a six liter flask containing a three inch stir bar. Place the flask onto a magnetic stirrer and mix the trypsin solution rapidly for a minimum of 1 h.

*The trypsin remains cloudy.*

Step b. Add 4 L of dH<sub>2</sub>O and a three-inch stir bar into a 20 liter clear plastic carboy. Place the carboy onto a magnetic stirrer and stir at a speed sufficient to develop a vortex while adding the following chemicals: 80 g NaCl, 12.5 g EDTA, 50 g glucose, 11.5 g Na<sub>2</sub>HPO<sub>4</sub> • 7H<sub>2</sub>O, 2.0 g KCl, and 2.0 g KH<sub>2</sub>PO<sub>4</sub>.

*Each chemical does not have to be completely dissolved before adding the next one.*

Step c. Add an additional 4 L dH<sub>2</sub>O to the carboy and continue mixing until all the chemicals are completely dissolved.

Step d. Add the 2 L of trypsin from Step 2a to the solution from Step 2c and mix for a minimum of 1 h. Adjust the pH of the EDTA-trypsin reagent to 7.5 - 7.7.

Step e. Filter the reagent under pressure through a filter stack and store the filtered reagent in tightly stoppered or capped containers at 4°C.

*The cartridge prefilter (Item 4 of Apparatus and Materials) can be used in line with the culture capsule sterilizing filter (Item 5) as an alternative to a filter stack (Item 3).*

2. Procedure for the preparation of 10 L of MEM/L-15 medium.

Step a. Place a three inch stir bar and 4 L of dH<sub>2</sub>O into a 20 liter clear plastic carboy.

Step b. Place the carboy onto a magnetic stirrer. Stir at a speed sufficient to develop a vortex and then add the contents of a five liter packet of L-15 medium to the carboy. Rinse the medium packet with three washes of 200 mL each of dH<sub>2</sub>O and add the rinses to the carboy.

Step c. Mix until the medium is evenly dispersed.

*L-15 medium may appear cloudy as it need not be totally dissolved before proceeding to Step d.*

Step d. Add 3 L of dH<sub>2</sub>O to the carboy and the contents of a five liter packet of MEM medium to the carboy. Rinse the MEM medium packet with three washes of 200 mL each of dH<sub>2</sub>O and add the rinses to the carboy. Add 800 mL of dH<sub>2</sub>O and 7.5 g of NaHCO<sub>3</sub> and continue mixing for an additional 60 min.

Step e. Transfer the MEM/L-15 medium to a pressure can and filter under positive pressure through a 0.22  $\mu\text{m}$  sterilizing filter. Collect the medium in volumes appropriate for the culturing of BGM cells (e.g., 900 mL in a one liter bottle) and store in tightly stoppered or capped containers at 4°C for up to two months.

*Note that the volume of the MEM/L-15 medium adds up to only 9 L to allow for the addition of serum to a final concentration of 10%.*

3. Procedure for preparation of 100 mL of trypan blue solution.

*The procedure is used in the direct determination of the viable cell counts of the BGM stock cultures. As trypan blue is on the U.S. EPA suspect carcinogen list, particular care should be taken in its preparation and use so as to avoid skin contact or inhalation. The wearing of rubber gloves during preparation and use is recommended.*

Step a. Add 0.5 g of trypan blue to 100 mL of dH<sub>2</sub>O in a 250 mL flask. Swirl the flask until the trypan blue is completely dissolved.

Step b. Sterilize the solution by autoclaving at 121 °C for 15 min and store in a screw-capped container at room temperature.

4. Preparation of 100 mL of penicillin-streptomycin stock solution containing 100,000 units/mL of penicillin and 100,000  $\mu\text{g/mL}$  of streptomycin.

Step a. Add 10,000,000 units of penicillin G and 10 g of streptomycin sulfate to a 250 mL flask containing 100 mL of dH<sub>2</sub>O. Mix the contents of the flasks on magnetic stirrer until the antibiotics are dissolved.

Step b. Sterilize the antibiotics by filtration through a 0.22  $\mu\text{m}$  membrane filter and dispense in 10 mL volumes into screw-capped containers.

5. Preparation of 50 mL of tetracycline stock solution.

Step a. Add 1.25 g of tetracycline hydrochloride powder and 3.75 g of ascorbic acid to a 125 mL flask containing 50 mL of dH<sub>2</sub>O. Mix the contents of the flask on a magnetic stirrer until the antibiotic is dissolved.

Step b. Sterilize the antibiotic by filtration through a 0.22  $\mu\text{m}$  membrane filter and dispense in 5 mL volumes into screw-capped containers.

6. Preparation of 25 mL of amphotericin B (fungizone) stock solution.

Step a. Add 0.125 g of amphotericin B to a 50 mL flask containing 25 mL of dH<sub>2</sub>O. Mix the contents of the flask on a magnetic stirrer until the antibiotic is dissolved.

Step b. Sterilize the antibiotic by filtration through a 0.22  $\mu\text{m}$  membrane filter and dispense in 2.5 mL volumes into screw-capped containers.

## PREPARATION AND PASSAGE OF BGM CELL CULTURES

*A microbiological biosafety cabinet should be used to process cell cultures. If a hood is not available, cell cultures should be prepared in controlled facilities used for no other purposes. Viruses or other microorganisms must not be transported, handled, or stored in rooms used for cell culture transfer.*

### **Vessels and Media for Cell Growth:**

1. The BGM cell line grows readily on the inside surfaces of glass or specially treated, tissue culture grade plastic vessels. Flat-sided, glass bottles (16 to 32 oz or equivalent growth area), 75 or 150  $\text{cm}^2$  plastic cell culture flasks, and 690  $\text{cm}^2$  glass or 850  $\text{cm}^2$  plastic roller bottles are usually used for the maintenance of stock cultures. Flat-sided bottles and flasks that contain cells in a stationary position are incubated with the flat side (cell monolayer side) down. If available, roller bottles and roller apparatus units are preferable to flat-sided bottles and flasks because roller cultures require less medium than flat-sided bottles per unit of cell monolayer surface area. Roller apparatus rotation speed should be adjusted to one-half revolution per minute to ensure that cells are constantly bathed in growth medium.

2. Growth and maintenance media should be prepared on the day they will be needed. Prepare growth medium by supplementing MEM/L-15 medium with 10% serum and antibiotics (100 mL of serum, 1 mL of penicillin-streptomycin stock, 0.5 mL of tetracycline stock and 0.2 mL of fungizone stock per 900 mL of MEM/L-15). Prepare maintenance medium by supplementing MEM/L-15 with antibiotics and 2% or 5% serum (20 or 50 mL of serum, antibiotics as above for growth medium and 80 or 50 mL of  $\text{dH}_2\text{O}$ , respectively). Use maintenance media with 2% serum for CPE development.

### **General Procedure for Cell Passage:**

*Pass stock BGM cell cultures at approximately seven day intervals using growth medium.*

Step 1. Pour spent medium from cell culture vessels, and discard the medium.

*A gauze-covered beaker may be used to collect spent medium to prevent splatter.*

*Autoclave all media that have been in contact with cells or that contain serum before discarding.*

Step 2. Add a volume of warm EDTA- trypsin reagent equal to 40% of the volume of medium that was discarded in Step 1.

*See **Table VIII-1** for the amount of reagents required for commonly used vessel types.*

*Warm the EDTA-trypsin reagent to  $36.5 \pm 1^\circ\text{C}$  before placing it onto cell monolayers.*

Step 3. Allow the EDTA-trypsin reagent to remain in contact with cells at room temperature until the cell monolayer can be shaken loose from the inner surface of the cell culture vessel.

*To prevent cell damage, the EDTA-trypsin reagent should remain in contact with the cells no longer than 5 min.*

Step 4. Pour the suspended cells into centrifuge tubes or bottles.

*To facilitate collection and resuspension of cell pellets, use tubes or bottles with conical bottoms. Centrifuge tubes and bottles used for this purpose must be able to withstand the g-force applied.*

Step 5. Centrifuge cell suspension at 1,000 ×g for 10 min to pellet cells. Pour off and discard the supernatant.

*Do not exceed this speed as cells may be damaged or destroyed.*

Step 6. Suspend the pelleted cells in growth medium (see Item 2 of **Vessels and Media for Cell Growth**) and perform a viable count on the cell suspension according to the **Procedure for Performing Viable Cell Counts** section below.

*Resuspend pelleted cells in a sufficient volume of medium to allow thorough mixing of the cells (to reduce sampling error) and to minimize the significance of the loss of the 0.5 mL of cell suspension required for the cell counting procedure. The quantity of medium used for resuspending pelleted cells varies from 50 to several hundred milliliters, depending upon the volume of the individual laboratory's need for cell cultures.*

<b>Table VIII-1. Guide for Preparation of BGM Stock Cultures</b>			
Vessel Type	Volume of EDTA-Trypsin (mL)	Volume of Medium (mL) <sup>a</sup>	Total No. Cells to Plate per Vessel
16 oz glass flat bottles	10	25	$2.5 \times 10^6$
32 oz glass flat bottles	20	50	$5.0 \times 10^6$
75 cm <sup>2</sup> plastic flat flask	12	30	$3.0 \times 10^6$
150 cm <sup>2</sup> plastic flat flask	24	60	$6.0 \times 10^6$
690 cm <sup>2</sup> glass roller bottle	40	100	$7.0 \times 10^6$
850 cm <sup>2</sup> plastic roller bottle	48	120	$8.0 \times 10^7$
<sup>a</sup> Serum requirements: growth medium contains 10% serum; maintenance medium contains 2-5% serum. Antibiotic requirements: penicillin-streptomycin stock solution, 1.0 mL/liter; tetracycline stock solution, 0.5 mL/liter; fungizone stock solution, 0.2 mL/liter.			

Step 7. Dilute the cell suspension to the appropriate final cell concentration with growth medium and dispense into cell culture vessels with a pipet, a Cornwall syringe or a Brewer- type pipetting machine dispenser.

*Calculate the dilution factor requirement using the cell count and*

*the cell and volume parameters given in **Table VIII-1** for stock cultures and in **Table VIII-2** for virus assay cultures.*

*As a general rule, the BGM cell line should be split at a 1:2 ratio for passages 117 to 150 and a 1:3 ratio for passages 151 to 250. To plant two hundred 25 cm<sup>2</sup> cell culture flasks weekly from cells between 151 and 250 passages would require the preparation of six roller bottles (surface area of 690 cm<sup>2</sup> each): The contents of two to prepare the next batch of six roller bottles and the contents of the other four to prepare the 25 cm<sup>2</sup> flasks.*

Step 8. Except during handling operations, maintain BGM cells at 36.5 ± 1 °C in airtight cell culture vessels.

Step 9. Replace growth medium with maintenance medium containing 2% serum when cell monolayers become 95 to 100% confluent (usually three to four days after seeding with an appropriate number of cells). Replace growth medium that becomes acidic before the monolayers become 95 to 100% confluent with maintenance medium containing 5% serum. The volume of maintenance medium should equal the volume of the discarded growth medium.

**Procedure For Performing Viable Cell Counts:**

Step 1. Add 0.5 mL of cell suspension (or diluted cell suspension) to 0.5 mL of 0.5% trypan blue solution in a test tube.

*To obtain an accurate cell count, the optimal total number of cells per hemocytometer section should be between 20 and 50. This range is equivalent to between 6.0 × 10<sup>5</sup> and 1.5 × 10<sup>6</sup> cells per mL of cell suspension. Thus, a dilution of 1:10 (0.5 mL of cells in 4.5 mL of growth medium) is usually required for an accurate count of a cell suspension.*

<b>Table VIII-2. Preparation of Virus Assay Cell Cultures</b>		
Vessel Type	Volume of Medium* (mL)	Final Cell Count per Vessel
1 oz glass bottle	4	9.0 × 10 <sup>5</sup>
25 cm <sup>2</sup> plastic flask	10	3.5 × 10 <sup>6</sup>
6 oz glass bottle	15	5.6 × 10 <sup>6</sup>
75 cm <sup>2</sup> plastic flask	30	1.0 × 10 <sup>7</sup>
16 mm × 150 mm tubes	2	4.0 × 10 <sup>4</sup>
*Serum requirements: growth medium contains 10% serum. Antibiotic requirements: penicillin- streptomycin stock solution, 1.0 mL/liter; tetracycline stock solution, 0.5 mL/liter; fungizone stock solution, 0.2 mL/liter.		

Step 2. Disperse cells by repeated pipetting.

*Avoid introducing air bubbles into the suspension, because air bubbles may interfere with subsequent filling of the hemocytometer chambers.*

Step 3. With a capillary pipette, carefully fill a hemocytometer chamber on one side of a slip-covered hemocytometer slide. Rest the slide on a flat surface for about 1 min to allow the trypan blue to penetrate the cell membranes of nonviable cells.

*Do not under or over fill the chambers.*

Step 4. Under 100X total magnification, count the cells in the four large corner sections and the center section of the hemocytometer chamber.

*Include in the count cells lying on the lines marking the top and left margins of the sections, and ignore cells on the lines marking the bottom and right margins. Trypan blue is excluded by living cells. Therefore, to quantify viable cells, count only cells that are clear in color. Do not count cells that are blue.*

Step 5. Calculate the average number of viable cells in each mL of cell suspension by totaling the number of viable cells counted in the five sections, multiplying this sum by 2000, and where necessary, multiplying the resulting product by the reciprocal of the dilution.

#### PROCEDURE FOR PRESERVATION OF BGM CELL LINE

*An adequate supply of frozen BGM cells must be available to replace working cultures that are used only periodically or become contaminated or lose virus sensitivity. Cells have been held at -70 °C for more than 15 years with a minimum loss in cell viability.*

##### **Preparation of Cells for Storage:**

*The procedure described is for the preparation of 100 cell culture vials. Cell concentration must be at least  $2 \times 10^6$  per mL.*

*The actual number of vials to be prepared should be based upon line usage and the anticipated time interval requirement between cell culture start-up and full culture production.*

Step 1. Prepare cell storage medium by adding 10 mL of DMSO to 90 mL of growth medium (see **Item 2 of Vessels and Media for Cell Growth**). Sterilize the resulting cell storage medium by passage through a 0.22  $\mu$ m sterilizing filter.

*Collect sterilized medium in a 250 mL flask containing a stir bar.*

Step 2. Harvest BGM cells from cell culture vessels as directed in Steps 1 to 5 of **General Procedures for Cell Passage**. Count the viable cells as described above and resuspend them in the cell storage medium at a concentration of at least  $2 \times 10^6$  cells per mL.

Step 3. Place the flask containing suspended cells on a magnetic stirrer and slowly mix for 30 min. Dispense 1 mL volumes of cell suspension into 2 mL capacity vials.

**Procedure for Freezing Cells:**

*The freezing procedure requires slow cooling of the cells with the optimum rate of -1 °C per min. A slow cooling rate can be achieved using the following method or by using the recently available freezing containers (e.g., Nalge Product No. 5100-0001) as recommended by the manufacturers.*

Step 1. Place the vials in a rack and place the rack in refrigerator at 4°C for 30 min, then in a -20°C freezer for 30 min, and finally in a -70°C freezer overnight. The transfers should be made as rapidly as possible.

*To allow for more uniform cooling, wells adjoining each vial should remain empty.*

Step 2. Rapidly transfer vials into boxes or other containers for long-term storage.

To prevent substantial loss of cells during storage, temperature of cells should be kept constant after -70°C has been achieved.

**Procedure for Thawing Cells:**

*Cells must be thawed rapidly to decrease loss in cell viability.*

Step 1. Place vials containing frozen cells into a  $36.5 \pm 1^\circ\text{C}$  water bath and agitate vigorously by hand until all ice has melted. Sterilize the outside surface of the vials with 0.5% I<sub>2</sub> in 70% ethanol.

Step 2. Add BGM cells to either 6 oz tissue culture bottles or 25 cm<sup>2</sup> tissue culture flasks containing an appropriate volume of growth medium (see **Table VIII-2**). Use two vials of cells for 6 oz bottles and one vial for 25 cm<sup>2</sup> flasks.

Step 3. Incubate BGM cells at  $36.5 \pm 1^\circ\text{C}$ . After 18 to 24 h replace the growth medium with fresh growth medium and then continue the incubation for an additional five days. Pass and maintain the new cultures as directed above.

## PART 5 — STERILIZATION AND DISINFECTION

### GENERAL GUIDELINES

1. Use aseptic techniques for handling test waters, eluates and cell cultures.
2. Sterilize apparatus and containers that will come into contact with test waters and all solutions that will be added to test waters unless otherwise indicated. Thoroughly clean all items before final sterilization using laboratory standard operating procedures.
3. Sterilize all contaminated materials before discarding.
4. Disinfect all spills and splatters.

### STERILIZATION TECHNIQUES

#### **Solutions:**

1. Sterilize all solutions, except those used for cleansing, standard buffers, hydrochloric acid (HCl), sodium hydroxide (NaOH), and disinfectants by autoclaving them at 121 °C for at least 15 min.

*The HCl and NaOH solutions and disinfectants used are self-sterilizing. When autoclaving buffered beef extract, use a vessel large enough to accommodate foaming.*

#### **Autoclavable Glassware, Plasticware, and Equipment:**

*Water speeds the transfer of heat in larger vessels during autoclaving and thereby speeds the sterilization process. Add dH<sub>2</sub>O to vessels in quantities indicated in **Table VIII-3**. Lay large vessels on their sides in the autoclave, if possible, to facilitate the displacement of air in the vessels by flowing steam.*

1. Cover the openings into autoclavable glassware, plasticware, and equipment loosely with aluminum foil before autoclaving. Autoclave at 121 °C for at least 30 min.  
*Glassware may also be sterilized in a dry heat oven at a temperature of 170 °C for at least 1 h.*
2. Sterilize stainless steel vessels (dispensing pressure vessel) in an autoclave at 121 °C for at least 30 min.  
*Vent-relief valves on vessels so equipped must be open during autoclaving and closed immediately when vessels are removed from autoclave.*
3. Presterilize 1MDS filter cartridges and prefilter cartridges by wrapping the filters in Kraft paper and autoclaving at 121 °C for 30 min.



4. Sterilize instruments, such as scissors and forceps, by immersing them in 95% ethanol and flaming them between uses.

<b>Table VIII-3. Water Quantity to be Added to Vessels Before Autoclaving</b>	
<b>Vessel Size (liter)</b>	<b>Quantity of dH<sub>2</sub>O (mL)</b>
2 and 3	25
4	50
8	100
24	500
54	1000

**Chlorine Sterilization:**

*Sterilize pumps, plastic-ware (filter housings) and tubing that cannot withstand autoclaving, and vessels that are too large for the autoclave by chlorination.*

*Prefilters, but not IMDS fil-*

*ters, may be presterilized with chlorine as an alternative to autoclaving. Filter apparatus modules should be disinfected by sterilization and then cleaned according to laboratory standard operating procedures before final sterilization.*

1. Media and Reagents

a. 0.1% chlorine (HOCl) — add 19 mL of household bleach (Clorox, The Clorox Co.) to 900 mL of dH<sub>2</sub>O and adjust the pH of the solution to 6-7 with 1 M HCl. Bring to 1 liter with dH<sub>2</sub>O.

2. Procedures

*Ensure that the solutions come in full contact with all surfaces when performing these procedures.*

a. Sterilize filter apparatus modules, injector tubing and plastic bags for transporting injector tubing by recirculating or immersing the items in 0.1% chlorine for 30 min. Drain the chlorine solution from objects being sterilized. Dechlorinate using a solution containing 2.5 mL of 2% sterile sodium thiosulfate per liter of sterile dH<sub>2</sub>O.

b. Thoroughly rinse pH electrodes after each use to remove particulates. Sterilize before and after each use by immersing the tip of the electrode in 0.1% chlorine for at least 1 min. Dechlorinate the electrode as in Step 2a above. Rinse with sterile dH<sub>2</sub>O.

PROCEDURE FOR VERIFYING STERILITY OF LIQUIDS

*Do not add antibiotics to media or medium components until after their sterility has been demonstrated. The BGM cell line used should be checked every six months for mycoplasma contamination according to test kit instructions. Cells that are contaminated should be discarded.*

### **Media and Reagents:**

1. Mycoplasma testing kit (Irvine Scientific Product No. T500-000). Use as directed by the manufacturer.
2. Thioglycollate medium (Difco Laboratories Product No. 0257-01-9). Prepare broth medium as directed by the manufacturer.

### **Verifying Sterility of Small Volumes of Liquids:**

Step 1. Inoculate 1 mL portions of the material to be tested for sterility into tubes containing 9 mL of thioglycollate broth by stabbing the inoculum into the broth. Incubate at  $36.5 \pm 1^\circ\text{C}$ .

Step 2. Examine the inoculated broth daily for seven days to determine whether growth of contaminating organisms has occurred.

*Containers holding the thioglycollate medium must be tightly sealed before and after the medium is inoculated.*

### **Visual Evaluation of Media for Microbial Contaminants:**

Step 1. Incubate either the entire stock of prepared media or portions taken during preparation that represent at least 5% of the final volume at  $36.5 \pm 1^\circ\text{C}$  for at least one week before use.

Step 2. Visually examine and discard any media that lose clarity.

*A clouded condition that develops in the media indicates the occurrence of contaminating organisms.*

### **CONTAMINATED MATERIALS**

1. Autoclave contaminated materials for at least 30 min at  $121^\circ\text{C}$ . Be sure that steam can enter contaminated materials freely.
2. Many commercial disinfectants do not adequately kill enteric viruses. To ensure thorough disinfection, disinfect spills and other contamination on surfaces with either a solution of 0.5% iodine in 70% ethanol (5 g  $\text{I}_2$  per liter) or 0.1% chlorine. The iodine solution has the advantage of drying more rapidly on surfaces than chlorine, but may stain some surfaces.

## PART 6 — BIBLIOGRAPHY AND SUGGESTED READING

APHA. 1995. Standard Methods for the Examination of Water and Wastewater (A. D. Eaton, L. S. Clesceri and A. E. Greenberg, ed), 19th Edition. American Public Health Association, Washington, D.C.

Barron, A. L., C. Olshevsky and M. M. Cohen. 1970. Characteristics of the BGM line of cells from African green monkey kidney. *Archiv. Gesam. Virusforsch.* **32**:389-392.

Berg, G., R. S. Safferman, D. R. Dahling, D. Berman and C. J. Hurst. 1984. USEPA Manual of Methods for Virology. U.S. Environmental Protection Agency Publication No. EPA/600/4-84/013, Cincinnati, OH.

Chang, S. L., G. Berg, K. A. Busch, R. E. Stevenson, N. A. Clarke and P. W. Kabler. 1958. Application of the "most probable number" method for estimating concentration of animal viruses by the tissue culture technique. *Virology* **6**:27-42.

Crow, E. L. 1956. Confidence intervals for a proportion. *Biometrika.* **43**:423-435.

Dahling, D. R. and B. A. Wright. 1986. Optimization of the BGM cell line culture and viral assay procedures for monitoring viruses in the environment. *Appl. Environ. Microbiol.* **51**:790-812.

Dahling, D. R. and B. A. Wright. 1987. Comparison of the in-line injector and fluid proportioner used to condition water samples for virus monitoring. *J. Virol. Meth.* **18**:67-71.

Dahling, D. R., G. Berg and D. Berman. 1974. BGM, a continuous cell line more sensitive than primary rhesus and African green kidney cells for the recovery of viruses from water. *Health Lab. Sci.* **11**:275-282.

Dahling, D. R., R. S. Safferman and B. A. Wright. 1984. Results of a survey of BGM cell culture practices. *Environ. Internat.* **10**:309-313.

Eagle, H. 1959. Amino acid metabolism in mammalian cell cultures. *Science.* **130**:432-437.

EPA. 1989. Guidance manual for compliance with the filtration and disinfection requirements for public water systems using surface water sources. Office of Drinking Water, Washington, D.C.

Freshney, R. I. 1983. Culture of Animal Cells: A Manual of Basic Technique. Alan R. Liss, New York, NY.

- Hay, R. J. 1985. ATCC Quality Control Methods for Cell Lines. American Type Culture Collection, Rockville, MD.
- Hurst, C. J. 1990. Field method for concentrating viruses from water samples, pp. 285-295. *In* G. F. Craun (ed.), *Methods for the Investigation and Prevention of Waterborne Disease Outbreaks*. U.S. Environmental Protection Agency Publication No. EPA/600/1-90/005a, Washington, D.C.
- Hurst, C. J. 1991. Presence of enteric viruses in freshwater and their removal by the conventional drinking water treatment process. *Bull. W.H.O.* **69**:113-119.
- Hurst, C. J. and T. Goyke. 1983. Reduction of interfering cytotoxicity associated with wastewater sludge concentrates assayed for indigenous enteric viruses. *Appl. Environ. Microbiol.* **46**:133-139.
- Katzenelson, E., B. Fattal and T. Hostovesky. 1976. Organic flocculation: an efficient second-step concentration method for the detection of viruses in tap water. *Appl. Environ. Microbiol.* **32**:638-639.
- Laboratory Manual in Virology. 1974. 2nd Ed. Ontario Ministry of Health, Toronto, Ontario, Canada.
- Leibovitz, A. 1963. The growth and maintenance of tissue-cell cultures in free gas exchange with the atmosphere. *Amer. J. Hyg.* **78**:173-180.
- Lennette, E. H., D.A. Lennette and E.T. Lennette (ed.). 1995. *Diagnostic Procedures for Viral, Rickettsial and Chlamydial Infections*, 7th ed. American Public Health Association, Washington, D.C.
- Malherbe, H. H. and M. Strickland-Cholmley. 1980. *Viral Cytopathology*. CRC Press. Boca Raton, FL.
- Morris, R. and W. M. Waite. 1980. Evaluation of procedures for recovery of viruses from water—II detection systems. *Water Res.* **14**:795-798.
- Paul, J. 1975. *Cell and Tissue Culture*. 5th Ed. Churchill Livingstone, London, Great Britain.
- Payment, P. and M. Trudel. 1985. Influence of inoculum size, incubation temperature, and cell culture density on virus detection in environmental samples. *Can. J. Microbiol.* **31**:977-980.

Rovozzo, G. C. and C. N. Burke. 1973. A Manual of Basic Virological Techniques. Prentice-Hall, Englewood Cliffs, NJ.

Sobsey, M. D. 1976. Field monitoring techniques and data analysis, pp. 87-96. *In* L. B. Baldwin, J. M. Davidson and J. F. Gerber (eds.), Virus Aspects of Applying Municipal Waste to Land. University of Florida, Gainesville, FL.

Sobsey, M. D. 1980. Poliovirus concentration from tap water with electropositive adsorbent filters. *Appl. Environ. Microbiol.* **40**:201-210.

Thomas, H. A., Jr. 1942. Bacterial densities from fermentation tube tests. *J. Amer. Water Works Assoc.* **34**:572-576.

Waymouth, C., R. G. Ham and P. J. Chapple. 1981. The Growth Requirements of Vertebrate Cells In Vitro. Cambridge University Press, Cambridge, Great Britain.

## PART 7 — VENDORS

The vendors listed below represent one possible source for required products. Other vendors may supply the same or equivalent products.

American Type Culture Collection  
12301 Parklawn Dr.  
Rockville, MD 20852  
(800) 638-6597

Baxter Diagnostics, Scientific Products Div.  
1430 Waukegan Rd.  
McGaw Park, IL 60085  
(800) 234-5227

BBL Microbiology Systems: products may be ordered through several major scientific supply houses

Becton Dickinson Microbiology Systems  
250 Schilling Circle  
Cockeysville, MD 21030  
(410) 771-0100 (Ask for a local distributor)

Bellco Glass  
340 Edrudo Rd.  
Vineland, NJ 08360  
(800) 257-7043

Brockway: products may be ordered through Continental Glass & Plastics

Cincinnati Valve and Fitting Co.  
3710 Southern Ave.  
Cincinnati, OH 45227  
(513) 272-1212

Cole-Parmer Instrument Co.  
7425 N. Oak Park Ave.  
Niles, IL 60714  
(800) 323-4340

Continental Glass & Plastics  
841 W. Cermak Rd.  
Chicago, IL 60608  
(312) 666-2050

Corning: products may be ordered through most major scientific supply houses

Costar Corp.  
7035 Commerce Circle  
Pleasanton, CA 94588  
(800) 882-7711

Cuno, Inc.  
400 Research Parkway  
Meriden, CT 06450  
(800)243-6894

Curtin Matheson Scientific  
P.O. Box 1546  
Houston, TX 77251  
(713) 820-9898

DEMA Engineering Co.  
10014 Big Bend Blvd.  
Kirkwood, MO 63122  
(800) 325-3362

Difco Laboratories  
P.O. Box 331058  
Detroit, MI 48232  
(800) 521-0851 (Ask for a local distributor)

Fisher Scientific  
711 Forbes Ave.  
Pittsburgh, PA 15219  
(800) 766-7000

Gelman Sciences  
600 S. Wagner Rd.  
Ann Arbor, MI 48103  
(800) 521-1520

ICN Biomedicals  
3300 Hyland Ave.  
Costa Mesa, CA 92626  
(800) 854-0530

Irvine Scientific  
2511 Daimler Street  
Santa Ana, CA 92705  
(800) 437-5706

Life Technologies  
P.O. Box 68  
Grand Island, NY 14072  
(800) 828-6686

Millipore Corp.  
397 Williams St.  
Marlboro, MA 01752  
(800) 225-1380

Nalge Co.  
P.O. Box 20365  
Rochester, NY 14602  
(716) 586-8800 (Ask for a local distributor)

Neptune Equipment Co.  
520 W. Sharon Rd.  
Forest Park, OH 45240  
(800) 624-6975

OMEGA Engineering, Inc.  
P.O. Box 4047  
Stamford, CT 06907  
(800) 826-6342

Plast-o-matic Valves, Inc.  
1384 Pompton Ave  
Cedar Grove, NJ 07009  
(201) 256-3000 (Ask for a local distributor)

Parker Hannifin Corp.  
Commercial Filters Div.  
1515 W. South St., Lebanon, IN 46052  
(317) 482-3900

Ryan Herco  
2509 N. Naomi St.  
Burbank, CA 91504  
(800) 848-1141

Sigma Chemical  
P.O. Box 14508  
St. Louis, MO 63178  
(800) 325-3010

United States Plastic Corp.  
1390 Neubrecht Rd.  
Lima, OH 45801  
(800) 537-9724

Watts Regulator  
Box 628  
Lawrence, MA 01845  
(508) 688-1811

## PART 8 — EXAMPLES

### EXAMPLE 1

A source water sample of 211.98 L was collected at the Sampleville Water Works on 5/1/95 and shipped by overnight courier to CEPOR Laboratories. CEPOR Laboratories processed the sample on 5/2/95. After elution, the pH of the beef extract V eluate was adjusted to 7.3 with 1 M HCl. The volume of the pH-adjusted eluate, 980 mL, was recorded. Volumes of 34.3 mL ( $980 \times 0.035$ ) and 98.0 mL ( $980 \times 0.1$ ) were removed for the **Coliphage Assay (Section IX)** and for archiving, respectively. An **Adjusted Total Sample Volume (ATSV)** was then calculated by multiplying  $211.98 \text{ L} \times 0.865$ . An ATSV of 183 L was recorded on the **Virus Data Sheet**.

The sample was immediately processed by the **Organic Flocculation Concentration Procedure**. Following centrifugation at  $4,000 \times g$ , the supernatant was adjusted to pH 7.3 and passed through a sterilizing filter. A **Final Concentrated Sample Volume (FCSV)** of 28.0 mL was obtained.

The **Assay Sample Volume** was calculated using the formula:

$$\text{ASSAY SAMPLE VOLUME (S)} = \frac{D}{\text{ATSV}} \times \text{FCSV}$$

where D is the **Volume of Original Water Sample Assayed** (i.e., 100 L for source water or 1000 L for finished water). Thus the **Assay Sample Volume** for Sampleville-01 is:

$$S = \frac{100 \text{ liters}}{183 \text{ liters}} \times 28.0 \text{ ml} = 15.3 \text{ ml}$$

The 15.3 mL is the volume of the **Final Concentrated Sample** that must be inoculated onto tissue culture and that represents 100 L of the source water.

Two subsamples were prepared from the **Final Concentrated Sample**. **Subsample 1** was prepared by placing  $0.55 \times 15.3 \text{ mL} = 8.4 \text{ mL}$  into a separate container. **Subsample 2** was prepared by placing  $0.67 \times 15.3 \text{ mL} = 10.2 \text{ mL}$  into a third container. Although only  $0.5 \times 15.3 = 7.65 \text{ mL}$  (representing 50 L of source water) must be inoculated onto tissue culture flasks for each subsample, the factor "0.55" was used for **subsample 1** to account for unrecoverable losses associated with removing a subsample from its container. The factor "0.67" was used for **subsample 2** to account for losses associated with the container and to provide additional sample for the preparation of dilutions, if required.



**Subsample 2** and the remaining portions of the **Final Concentrated Sample** were frozen at  $-70^{\circ}\text{C}$ .

The **inoculation volume** was calculated to be  $15.3 \text{ mL} \div 20 = 0.76 \text{ mL}$  per flask. To make the inoculation procedure more convenient, it was decided to dilute **subsample 1** so that 1.0 mL of inoculum contained an amount of **subsample 1** equal to the **inoculum volume**. To do this,  $10.5 \times (1.00 - 0.76) = 2.52 \text{ mL}$  of  $0.15 \text{ M Na}_2\text{HPO}_4 \cdot 7\text{H}_2\text{O}$ , pH 7.3, was added to  $10.5 \times 0.76 = 7.98 \text{ mL}$  of **subsample 1**. One milliliter of diluted **subsample 1** was then inoculated onto each of ten  $25 \text{ cm}^2$  flasks of BGM cells at passage 123. A **negative control** was prepared by inoculating a flask with 1.0 mL of  $0.15 \text{ M Na}_2\text{HPO}_4 \cdot 7\text{H}_2\text{O}$ , pH 7.3. A **positive control** was prepared by inoculating a flask with 1.0 mL of  $0.15 \text{ M Na}_2\text{HPO}_4 \cdot 7\text{H}_2\text{O}$ , pH 7.3 containing 200 PFU/mL of attenuated poliovirus type 3. Following adsorption, 9.0 mL of maintenance medium was added and the cultures were incubated at  $36.5^{\circ}\text{C}$ . These cultures and those described below were observed for CPE as described in the protocol and positive cultures were frozen when 75% of a flask showed signs of CPE.

On May 9th five flasks inoculated with **subsample 1** and the positive control showed signs of CPE. Because fewer than eight flasks inoculated with **subsample 1** showed CPE, 10 additional  $25 \text{ cm}^2$  flasks of BGM cells at passage 124 were inoculated with 1.0 mL each of **subsample 2** diluted in the same manner as **subsample 1**. Another **negative control** and **positive control** were also prepared and inoculated.

By May 16th a total of seven flasks inoculated with **subsample 1** showed signs of CPE. The flasks that had not been previously frozen were now frozen at  $-70^{\circ}\text{C}$  and then all flasks were thawed. Several milliliters of fluid from each of the eight positive flasks (seven samples plus the positive control) were passed through a sterilizing filter. Twelve flasks of BGM cells at passage 125 were inoculated with one milliliter of the supernatant from either negative cultures or from filtered positive cultures.

By May 23rd a total of five flasks from **subsample 2** showed signs of CPE. All flasks were frozen, thawed and then passaged as described for **subsample 1** using BGM cells at passage 126.

By May 30th only six flasks from the second passage of **subsample 1** and the positive control showed CPE. Thus one culture from the 1st passage failed to confirm in the second pass and a value of 6 was recorded in the **Number of Replicates with CPE** column of the **Total Culturable Virus Data Sheet**. The flasks were then discarded.

On June 6th seven flasks (the five original plus two new flasks) from the second passage of **subsample 2** demonstrated CPE. The two new flasks and controls were frozen at  $-70^{\circ}\text{C}$ , thawed and passaged a third time as described above using BGM cells at passage 127. All other flasks were discarded.

By June 12 the positive control and the two third passage flasks had developed CPE. All flasks were discarded at this time (the flasks would have been examined until 6/20 if at least one had remained negative). A value of 7 was recorded into the **Number of Replicates with CPE** column of the **Total Culturable Virus Data Sheet**.

The MPN software program supplied by the U.S. EPA was used to calculate the MPN/mL and 95% confidence limit values. "I. SIZE OF INOCULUM VOLUME (mL)" on the main screen was changed from 1 to 0.76. "A. PROCEED WITH DATA INPUT" was pressed followed by "ENTER" to overwrite the existing output file. Alternatively, "NO" could have been entered and the output file renamed. The number of positive replicates, "13," was then entered. Following the calculation by the program, the MPN and 95% Confidence Limit values were recorded onto the **Quantitation of Total Culturable Virus Data Sheet**. The program was exited by pressing "I. EXIT THE PROGRAM."

The MPN per 100 liter value ( $M_l$ ) was calculated according to the formula:

$$M_l = \frac{100 M_m S}{D} = \frac{100 \times 1.38 \times 15.3}{100} = 21.1$$

where  $M_m$  is the MPN value per milliliter from the **Quantitation of Total Culturable Virus Data Sheet**,  $S$  is the **Assay Sample Volume** and  $D$  is the **Volume of Original Water Sample Assayed** ( $S$  and  $D$  are obtained from the **Virus Data Sheet**).

The Lower 95% Confidence Limit per 100 liter ( $CL_l$ ) was calculated according to the formula:

$$CL_l = \frac{100 CL_{lm} S}{D} = \frac{100 \times 0.70 \times 15.3}{100} = 10.7$$

where  $CL_{lm}$  is the lower 95% confidence limit per milliliter from the **Quantitation of Total Culturable Virus Data Sheet**.

The Upper 95% Confidence Limit per 100 liter ( $CL_u$ ) was calculated according to the formula:

$$CL_u = \frac{100 CL_{um} S}{D} = \frac{100 \times 2.27 \times 15.3}{100} = 34.7$$

where  $CL_{um}$  is the upper 95% confidence limit per milliliter from the **Quantitation of Total Culturable Virus Data Sheet**.

<b>SAMPLE DATA SHEET</b>	
<b>SAMPLE NUMBER:</b>	Sampleville-01
<b>UTILITY NAME:</b>	Sampleville Water Works
<b>UTILITY ADDRESS:</b>	1 Water Street
<b>CITY:</b> Sampleville	<b>STATE:</b> OH <b>ZIP:</b> 45999
<b>SAMPLER'S NAME:</b>	Mr. Brian Hall
<b>WATER TEMPERATURE:</b> 23.5 °C	<b>TURBIDITY:</b> 3.6 NTU
<b>WATER pH:</b>	7.8
<b>ADJUSTED WATER pH:</b>	NA
<b>THIOSULFATE ADDED:</b>	(CHECK) <u>  </u> YES <u>  X  </u> NO
<b>INIT. METER READING:</b> 6048.10	<b>CHECK UNITS:</b> <u>  X  </u> gallons <u>  </u> ft <sup>3</sup>
<b>date:</b> 5/1/95	<b>time:</b> 9 am
<b>FINAL METER READING:</b> 6104.10	<b>CHECK UNITS:</b> <u>  X  </u> gallons <u>  </u> ft <sup>3</sup>
<b>date:</b> 5/1/95	<b>time:</b> 9:30 am
<b>TOTAL SAMPLE VOLUME:</b>	211.98 L
(Final-Initial meter readings × 3.7854 (for readings in gallons) or × 28.316 (for readings in ft <sup>3</sup> ))	
<b>SHIPMENT DATE:</b>	5/1/95
<b>CONDITION ON ARRIVAL:</b>	Cold/Not frozen
<b>COMMENTS:</b>	

<b>VIRUS DATA SHEET</b>			
<b>SAMPLE NUMBER: SAMPLEVILLE-01</b>			
<b>ANALYTICAL LABORATORY NAME: CEPOR LABORATORIES</b>			
<b>ANALYTICAL LABORATORY ADDRESS: 42 RUECKERT ST.</b>			
<b>CITY: CINCINNATI</b>		<b>STATE: OH</b>	<b>ZIP: 45219</b>
<b>ADJUSTED TOTAL SAMPLE VOLUME (ATSV):<sup>1</sup></b>		<b>183 L</b>	
<b>DATE ELUTED: 5/2/95</b>		<b>TIME: 10 am</b>	
<b>ELUATE VOLUME RECOVERED:</b>		<b>980 mL</b>	
<b>VOLUME OF ELUATE ARCHIVED:</b>		<b>98.0 mL</b>	
<b>DATE CONCENTRATED: 5/2/95</b>		<b>TIME: 1 pm</b>	
<b>FINAL CONCENTRATED SAMPLE VOLUME (FCSV):</b>		<b>28.0 mL</b>	
<b>ASSAY SAMPLE VOLUME (S):</b>		<b>15.3 mL</b>	
<b>VOLUME OF ORIGINAL WATER SAMPLE ASSAYED (D):</b>		<b>100 L<sup>2</sup></b>	
<b>INOCULUM VOLUME:</b>		<b>0.76 mL</b>	
<b>DATES ASSAYED BY CPE:</b>	<b>1st Passage</b>	<b>2nd Passage</b>	<b>3rd Passage (If necessary)</b>
<b>Subsample 1:</b>	<b>5/2/95</b>	<b>5/16/95</b>	
<b>Subsample 2:</b>	<b>5/9/95</b>	<b>5/23/95</b>	<b>6/6/95</b>
		<b>95% CONFIDENCE LIMITS</b>	
<b>MPN/100 L<sup>3</sup>:</b>	<b>21</b>	<b>LOWER: 11</b>	<b>UPPER: 35</b>
<b>COMMENTS:</b>			
<b>ANALYST: B.G. Moore</b>			
<sup>1</sup> Enter the Total Sample Volume times 0.965 if a coliphage sample is taken, times 0.9 if archiving is required, times 0.865 if a coliphage sample is taken and archiving is required or times 1 if a coliphage sample is not taken and archiving is not required. <sup>2</sup> Must be at least 100 L for source water and 1000 L for finished water. <sup>3</sup> Value calculated from the Quantitation of Total Culturable Virus form as described in the Virus Quantitation section of Part 3.			

## TOTAL CULTURABLE VIRUS DATA SHEET

**SAMPLE #: Sampleville-01**

	Total Number of Replicates					
	Subsample 1			Subsample 2		
	Sample	Inoculated	Without CPE	With CPE	Inoculated	Without CPE
1st Passage Neg. Cont.	1	1	0	1	1	0
Pos. Cont.	1	0	1	1	0	1
Undiluted	10	3	7	10	5	5
1:5 Dil.						
1:25 Dil.						
2nd Passage <sup>1</sup> Neg. Cont.	1	1	0	1	1	0
Pos. Cont.	1	0	1	1	0	1
Undiluted	10	4	6	10	3	7
1:5 Dil.						
1:25 Dil.						
3rd Passage <sup>2</sup> Neg. Cont.				1	1	0
Pos. Cont.				1	0	1
Undiluted				2	0	2
1:5 Dil.						
1:25 Dil.						

<sup>1</sup>A portion of medium from each 1st passage vessel, including controls, must be repassaged for conformation. The terms "Undiluted," "1:5 Dilution" and "1:25 Dilution" under the 2nd and 3rd Passage headings refer to the original sample dilutions for the 1st passage. If higher dilutions are used, record the data from the three highest dilutions showing positive results and place the actual dilution amount in the sample column.

<sup>2</sup>Samples that were negative on the first passage and positive on the 2nd passage must be passaged a third time for conformation. If a third passage is required, all controls must be passaged again.

<b>QUANTITATION OF TOTAL CULTURABLE VIRUS DATA SHEET</b>					
<b>SAMPLE NUMBER: Sampleville-01</b>					
<b>Sample</b>	<b>Number Replicates inoculated</b>	<b>Number with CPE</b>	<b>MPN/mL<sup>1</sup></b>	<b>95% Confidence Limits</b>	
				<b>Lower</b>	<b>Upper</b>
<b>Undiluted Samples</b>			<b>1.38</b>	<b>0.70</b>	<b>2.27</b>
<b>Subsample 1</b>	<b>10</b>	<b>6</b>			
<b>Subsample 2</b>	<b>10</b>	<b>7</b>			
<b>Total Undiluted</b>	<b>20</b>	<b>13</b>			
<b>Subsample 2 results (Dilutions Required)</b>					
<b>Undiluted</b>					
<b>1:5 Dilution</b>					
<b>1:25 Dilution</b>					
<p><sup>1</sup>Use the values recorded in the Total Undiluted row to calculate the MPN/mL result and confidence limits when dilutions are not required. If dilutions are required, base the calculation upon the values recorded in the Undiluted, 1:5 Diluted and 1:25 Diluted rows for subsample 2. If higher dilutions are used for subsample 2, record the data from the three highest dilutions showing positive results and place the actual dilution amount in the sample column. The MPN/mL and 95% Confidence Limit values must be obtained using the computer program supplied by the U.S. EPA.</p>					

## EXAMPLE 2

A source water sample of 200.63 L was collected at the Sampleville Water Works on 6/5/95 and shipped by overnight courier to CEPOR Laboratories. CEPOR Laboratories processed the sample on 6/6/95. After elution, the pH was adjusted to 7.3. A volume of 985 mL of pH-adjusted eluate was obtained and 34.5 mL ( $985 \text{ mL} \times 0.035$ ) was removed for the **Coliphage Assay (Section IX)**. Archiving was not required. An **Adjusted Total Sample Volume** of 194 L ( $200.63 \text{ L} \times 0.965$ ) was recorded on the **Virus Data Sheet**.

The sample was immediately processed by the **Organic Flocculation Concentration Procedure**. Following centrifugation at  $4,000 \times g$ , the supernatant was adjusted to pH 7.3 and passed through a sterilizing filter. A **Final Concentrated Sample Volume** of 32.0 mL was obtained, giving an **Assay Sample Volume** for Sampleville-02 of:

$$S = \frac{100 \text{ liters}}{194 \text{ liters}} \times 32.0 \text{ ml} = 16.5 \text{ ml}$$

**Subsample 1** was prepared by placing  $0.55 \times 16.5 \text{ mL} = 9.1 \text{ mL}$  into a separate container. **Subsample 2** was prepared by placing  $0.67 \times 16.5 \text{ mL} = 11.1 \text{ mL}$  into a third container. **Subsample 2** and the remaining portions of the **Final Concentrated Sample** were frozen at  $-70^\circ\text{C}$ .

**Subsample 1** was inoculated onto each of ten  $25 \text{ cm}^2$  flasks of BGM cells at passage 127 using an **inoculation volume** of  $16.5 \text{ mL} \div 20 = 0.82 \text{ mL}$  per flask. A **negative control** was prepared by inoculating a flask with 0.82 mL of 0.15 M  $\text{Na}_2\text{HPO}_4 \cdot 7\text{H}_2\text{O}$ , pH 7.3. A **positive control** was prepared by inoculating a flask with 0.82 mL of 0.15 M  $\text{Na}_2\text{HPO}_4 \cdot 7\text{H}_2\text{O}$ , pH 7.3 containing 241.0 PFU/mL ( $200.0 \text{ PFU}/0.82 \text{ mL}$ ) of attenuated poliovirus type 3. Following adsorption, 9.18 mL of maintenance medium was added and the cultures were incubated at  $36.5^\circ\text{C}$ .

On June 13 nine flasks inoculated with **subsample 1** and the positive control showed signs of CPE. After thawing **subsample 2**, a 1:5 dilution was prepared by mixing  $0.1334 \times 16.5 = 2.20 \text{ mL}$  of **subsample 2** with  $0.5334 \times 16.5 = 8.80 \text{ mL}$  of 0.15 M  $\text{Na}_2\text{HPO}_4 \cdot 7\text{H}_2\text{O}$ , pH 7.3. A 1:25 dilution was prepared by mixing 2.20 mL of the 1:5 dilutions with 8.80 mL of 0.15 M  $\text{Na}_2\text{HPO}_4 \cdot 7\text{H}_2\text{O}$ , pH 7.3. Ten  $25 \text{ cm}^2$  flasks of BGM cells at passage 128 were then inoculated with 0.82 mL each of undiluted **subsample 2**. Ten flasks were inoculated with 0.82 mL each of **subsample 2** diluted 1:5 and ten flasks were inoculated with 0.82 mL each of **subsample 2** diluted 1:25. Another **negative control** and **positive control** were also prepared and inoculated.

By June 20 all 10 flasks inoculated with **subsample 1** showed signs of CPE and were repassaged as described in example 1.



By June 27 all 10 flasks inoculated with undiluted **subsample 2** had developed CPE. Eight flasks inoculated with the 1:5 dilution of **subsample 2** and four flasks inoculated with the 1:25 dilution of **subsample 2** demonstrated CPE. All flasks were re-passaged as described for example 1.

By July 5th all 10 flasks from the second passage of **subsample 1** were confirmed as positive and were discarded.

By July 11th all 10 flasks inoculated with the second passage of undiluted **subsample 2** had developed CPE. The eight positive flasks from the 1st passage of the 1:5 dilution of **subsample 2** were positive in the second passage. Three flasks inoculated with the second passage of the 1:25 dilution of **subsample 2** remained positive.

The MPN software program supplied by the U.S. EPA was used to calculate the MPN/mL and 95% confidence limit values. After the main screen appeared, "G. NUMBER OF DILUTIONS" was changed from 1 to 3. "H. NUMBER OF REPLICATES PER DILUTION" was changed from 20 to 10 and "I. SIZE OF INOCULUM VOLUME (mL)" was changed from 1 to 0.82. "A. PROCEED WITH DATA INPUT" was pressed followed by "ENTER" to overwrite the existing output file. The number of positive replicates per dilution, "10, 8, and 3" was entered with the values separated by spaces. Following program calculations, the MPN/mL and 95% Confidence Limit values/mL were recorded onto the **Quantitation of Total Culturable Virus Data Sheet**. The program was exited by pressing "I. EXIT THE PROGRAM."

The MPN per 100 liter value ( $M_l$ ) was calculated according to the formula:

$$M_l = \frac{100 M_m S}{D} = \frac{100 \times 10.15 \times 16.5}{100} = 167$$

where  $M_m$  is the MPN value per milliliter from the **Quantitation of Total Culturable Virus Data Sheet**,  $S$  is the **Assay Sample Volume** and  $D$  is the **Volume of Original Water Sample Assayed** ( $S$  and  $D$  are obtained from the **Virus Data Sheet**).

The Lower 95% Confidence Limit per 100 liter ( $CL_l$ ) was calculated according to the formula:

$$CL_l = \frac{100 CL_{lm} S}{D} = \frac{100 \times 5.04 \times 16.5}{100} = 83.1$$

where  $CL_{lm}$  is the lower 95% confidence limit per milliliter from the **Quantitation of Total Culturable Virus Data Sheet**.

The Upper 95% Confidence Limit per 100 liter ( $CL_u$ ) was calculated according to the formula:

$$CL_u = \frac{100 CL_{um} S}{D} = \frac{100 \times 18.25 \times 16.5}{100} = 301$$

where  $CL_{um}$  is the upper 95% confidence limit per milliliter from the **Quantitation of Total Culturable Virus Data Sheet**.

<b>SAMPLE DATA SHEET</b>			
<b>SAMPLE NUMBER:</b>	<b>Sampleville-02</b>		
<b>UTILITY NAME:</b>	<b>Sampleville Water Works</b>		
<b>UTILITY ADDRESS:</b>	<b>1 Water Street</b>		
<b>CITY:</b>	<b>Sampleville</b>	<b>STATE:</b>	<b>OH ZIP: 45999</b>
<b>SAMPLER'S NAME:</b>	<b>Mr. Brian Hall</b>		
<b>WATER TEMPERATURE:</b>	<b>26.5 °C</b>	<b>TURBIDITY:</b>	<b>2.3 NTU</b>
<b>WATER pH:</b>	<b>7.7</b>		
<b>ADJUSTED WATER pH:</b>	<b>NA</b>		
<b>THIOSULFATE ADDED:</b>	<b>(CHECK)</b>	<b>_ YES</b>	<b><u>X</u> NO</b>
<b>INIT. METER READING:</b>	<b>6129.3</b>	<b>CHECK UNITS:</b>	<b><u>X</u> gallons _ ft<sup>3</sup></b>
<b>date:</b>	<b>6/5/95</b>	<b>time:</b>	<b>8:30 am</b>
<b>FINAL METER READING:</b>	<b>6182.3</b>	<b>CHECK UNITS:</b>	<b><u>X</u> gallons _ ft<sup>3</sup></b>
<b>date:</b>	<b>6/5/95</b>	<b>time:</b>	<b>9:00 am</b>
<b>TOTAL SAMPLE VOLUME:</b>	<b>200.63 L</b>		
	<b>(Final-Initial meter readings × 3.7854 (for readings in gallons) or × 28.316 (for readings in ft<sup>3</sup>))</b>		
<b>SHIPMENT DATE:</b>	<b>6/5/95</b>		
<b>CONDITION ON ARRIVAL:</b>	<b>Cold/Not frozen</b>		
<b>COMMENTS:</b>			

<b>VIRUS DATA SHEET</b>			
<b>SAMPLE NUMBER: SAMPLEVILLE-02</b>			
<b>ANALYTICAL LABORATORY NAME: CEPOR LABORATORIES</b>			
<b>ANALYTICAL LABORATORY ADDRESS: 42 RUECKERT ST.</b>			
<b>CITY: CINCINNATI</b>		<b>STATE: OH</b>	<b>ZIP: 45219</b>
<b>ADJUSTED TOTAL SAMPLE VOLUME (ATSV):<sup>1</sup></b>			<b>194 L</b>
<b>DATE ELUTED: 6/6/95</b>		<b>TIME: 9:50 am</b>	
<b>ELUATE VOLUME RECOVERED:</b>			<b>985 mL</b>
<b>VOLUME OF ELUATE ARCHIVED:</b>			<b>0 mL</b>
<b>DATE CONCENTRATED: 6/6/95</b>		<b>TIME: 1 pm</b>	
<b>FINAL CONCENTRATED SAMPLE VOLUME (FCSV):</b>			<b>32.0 mL</b>
<b>ASSAY SAMPLE VOLUME (S):</b>			<b>16.5 mL</b>
<b>VOLUME OF ORIGINAL WATER SAMPLE ASSAYED (D):</b>			<b>100 L<sup>2</sup></b>
<b>INOCULUM VOLUME:</b>			<b>0.82 mL</b>
<b>DATES ASSAYED BY CPE:</b>	<b>1st Passage</b>	<b>2nd Passage</b>	<b>3rd Passage (If necessary)</b>
<b>Subsample 1:</b>	<b>6/6/95</b>	<b>6/20/95</b>	
<b>Subsample 2:</b>	<b>6/13/95</b>	<b>6/27/95</b>	
		<b>95% CONFIDENCE LIMITS</b>	
<b>MPN/100 L<sup>3</sup>:</b>	<b>167</b>	<b>LOWER: 83</b>	<b>UPPER: 301</b>
<b>COMMENTS:</b>			
<b>ANALYST: B.G. Moore</b>			
<sup>1</sup> Enter the Total Sample Volume times 0.965 if a coliphage sample is taken, times 0.9 if archiving is required, times 0.865 if a coliphage sample is taken and archiving is required or times 1 if a coliphage sample is not taken and archiving is not required. <sup>2</sup> Must be at least 100 L for source water and 1000 L for finished water. <sup>3</sup> Value calculated from the Quantitation of Total Culturable Virus form as described in the Virus Quantitation section of Part 3.			

<b>TOTAL CULTURABLE VIRUS DATA SHEET</b>						
<b>SAMPLE #: Sampleville-02</b>						
	<b>Total Number of Replicates</b>					
	<b>Subsample 1</b>			<b>Subsample 2</b>		
<b>Sample</b>	<b>Inoculated</b>	<b>Without CPE</b>	<b>With CPE</b>	<b>Inoculated</b>	<b>Without CPE</b>	<b>With CPE</b>
<b>1st Passage Neg. Cont.</b>	<b>1</b>	<b>1</b>	<b>0</b>	<b>1</b>	<b>1</b>	<b>0</b>
<b>Pos. Cont.</b>	<b>1</b>	<b>0</b>	<b>1</b>	<b>1</b>	<b>0</b>	<b>1</b>
<b>Undiluted</b>	<b>10</b>	<b>0</b>	<b>10</b>	<b>10</b>	<b>0</b>	<b>10</b>
<b>1:5 Dil.</b>				<b>10</b>	<b>2</b>	<b>8</b>
<b>1:25 Dil.</b>				<b>10</b>	<b>6</b>	<b>4</b>
<b>2nd Passage<sup>1</sup> Neg. Cont.</b>	<b>1</b>	<b>1</b>	<b>0</b>	<b>1</b>	<b>1</b>	<b>0</b>
<b>Pos. Cont.</b>	<b>1</b>	<b>0</b>	<b>1</b>	<b>1</b>	<b>0</b>	<b>1</b>
<b>Undiluted</b>	<b>10</b>	<b>0</b>	<b>10</b>	<b>10</b>	<b>0</b>	<b>10</b>
<b>1:5 Dil.</b>				<b>10</b>	<b>2</b>	<b>8</b>
<b>1:25 Dil.</b>				<b>10</b>	<b>7</b>	<b>3</b>
<b>3rd Passage<sup>2</sup> Neg. Cont.</b>						
<b>Pos. Cont.</b>						
<b>Undiluted</b>						
<b>1:5 Dil.</b>						
<b>1:25 Dil.</b>						

<sup>1</sup>A portion of medium from each 1st passage vessel, including controls, must be repassaged for conformation. The terms "Undiluted," "1:5 Dilution" and "1:25 Dilution" under the 2nd and 3rd Passage headings refer to the original sample dilutions for the 1st passage. If higher dilutions are used, record the data from the three highest dilutions showing positive results and place the actual dilution amount in the sample column.

<sup>2</sup>Samples that were negative on the first passage and positive on the 2nd passage must be passaged a third time for conformation. If a third passage is required, all controls must be passaged again.

**QUANTITATION OF TOTAL CULTURABLE VIRUS DATA SHEET**

**SAMPLE NUMBER: Sampleville-02**

Sample	Number Replicates inoculated	Number with CPE	MPN/mL <sup>1</sup>	95% Confidence Limits	
				Lower	Upper
<b>Undiluted Samples</b>			<b>10.15</b>	<b>5.04</b>	<b>18.25</b>
Subsample 1	10	10			
Subsample 2					
Total Undiluted	NA	NA			
<b>Subsample 2 results (Dilutions Required)</b>					
Undiluted	10	10			
1:5 Dilution	10	8			
1:25 Dilution	10	3			

<sup>1</sup>Use the values recorded in the Total Undiluted row to calculate the MPN/mL result and confidence limits when dilutions are not required. If dilutions are required, base the calculation upon the values recorded in the Undiluted, 1:5 Diluted and 1:25 Diluted rows for subsample 2. If higher dilutions are used for subsample 2, record the data from the three highest dilutions showing positive results and place the actual dilution amount in the sample column. The MPN/mL and 95% Confidence Limit values must be obtained using the computer program supplied by the U.S. EPA.

## **PART 9 — DATA SHEETS <sup>7</sup>**

---

<sup>7</sup>Copies of all Data Sheets are available upon request in WordPerfect for Windows, version 6.1 format. Send requests to the ICR Laboratory Coordinator, USEPA, TSD, 26 W. Martin Luther King Drive, Cincinnati, OH 45268.

<b>SAMPLE DATA SHEET</b>			
<b>SAMPLE NUMBER:</b>			
<b>UTILITY NAME:</b>			
<b>UTILITY ADDRESS:</b>			
<b>CITY:</b>	<b>STATE:</b>	<b>ZIP:</b>	
<b>SAMPLER'S NAME:</b>			
<b>WATER TEMPERATURE:</b>	<b>°C</b>	<b>TURBIDITY:</b>	<b>NTU</b>
<b>WATER pH:</b>			
<b>ADJUSTED WATER pH:</b>			
<b>THIOSULFATE ADDED:</b> (CHECK) <input type="checkbox"/> YES <input type="checkbox"/> NO			
<b>INIT. METER READING:</b>	<b>CHECK UNITS:</b>	<b>__gallons</b>	<b>__ft<sup>3</sup></b>
<b>date:</b>	<b>time:</b>		
<b>FINAL METER READING:</b>	<b>CHECK UNITS:</b>	<b>__gallons</b>	<b>__ft<sup>3</sup></b>
<b>date:</b>	<b>time:</b>		
<b>TOTAL SAMPLE VOLUME:</b>		<b>L</b>	
(Final-Initial meter readings × 3.7854 (for readings in gallons) or × 28.316 (for readings in ft <sup>3</sup> ))			
<b>SHIPMENT DATE:</b>			
<b>CONDITION ON ARRIVAL:</b>			
<b>COMMENTS:</b>			



<b>VIRUS DATA SHEET</b>			
<b>SAMPLE NUMBER:</b>			
<b>ANALYTICAL LABORATORY NAME:</b>			
<b>ANALYTICAL LABORATORY ADDRESS:</b>			
<b>CITY:</b>	<b>STATE:</b>	<b>ZIP:</b>	
<b>ADJUSTED TOTAL SAMPLE VOLUME (ATSV):<sup>1</sup></b>			<b>L</b>
<b>DATE ELUTED:</b>		<b>TIME:</b>	
<b>ELUATE VOLUME RECOVERED:</b>			<b>mL</b>
<b>VOLUME OF ELUATE ARCHIVED:</b>			<b>mL</b>
<b>DATE CONCENTRATED:</b>		<b>TIME:</b>	
<b>FINAL CONCENTRATED SAMPLE VOLUME (FCSV):</b>			<b>mL</b>
<b>ASSAY SAMPLE VOLUME (S):</b>			<b>mL</b>
<b>VOLUME OF ORIGINAL WATER SAMPLE ASSAYED (D):</b>			<b>L</b>
<b>INOCULUM VOLUME:</b>			<b>mL</b>
<b>DATES ASSAYED BY CPE:</b>	<b>1st Passage</b>	<b>2nd Passage</b>	<b>3rd Passage (If necessary)</b>
<b>Subsample 1:</b>			
<b>Subsample 2:</b>			
<b>MPN/100 L<sup>3</sup>:</b>		<b>95% CONFIDENCE LIMITS</b>	
		<b>LOWER:</b>	<b>UPPER:</b>
<b>COMMENTS:</b>			
<b>ANALYST:</b>			
<sup>1</sup> Enter the Total Sample Volume times 0.965 if a coliphage sample is taken, times 0.9 if archiving is required, times 0.865 if a coliphage sample is taken and archiving is required or times 1 if a coliphage sample is not taken and archiving is not required. <sup>2</sup> Must be at least 100 L for source water and 1000 L for finished water. <sup>3</sup> Value calculated from the Quantitation of Total Culturable Virus form as described in the Virus Quantitation section of Part 3.			

**TOTAL CULTURABLE VIRUS DATA SHEET**

**SAMPLE #:**

Sample	Total Number of Replicates					
	Subsample 1			Subsample 2		
	Inoculated	Without CPE	With CPE	Inoculated	Without CPE	With CPE
<b>1st Passage</b>						
<b>Neg. Cont.</b>						
<b>Pos. Cont.</b>						
<b>Undiluted</b>						
<b>1:5 Dil.</b>						
<b>1:25 Dil.</b>						
<b>2nd Passage<sup>1</sup></b>						
<b>Neg. Cont.</b>						
<b>Pos. Cont.</b>						
<b>Undiluted</b>						
<b>1:5 Dil.</b>						
<b>1:25 Dil.</b>						
<b>3rd Passage<sup>2</sup></b>						
<b>Neg. Cont.</b>						
<b>Pos. Cont.</b>						
<b>Undiluted</b>						
<b>1:5 Dil.</b>						
<b>1:25 Dil.</b>						

<sup>1</sup>A portion of medium from each 1st passage vessel, including controls, must be re-passaged for conformation. The terms "Undiluted," "1:5 Dilution" and "1:25 Dilution" under the 2nd and 3rd Passage headings refer to the original sample dilutions for the 1st passage. If higher dilutions are used, record the data from the three highest dilutions showing positive results and place the actual dilution amount in the sample column.

<sup>2</sup>Samples that were negative on the first passage and positive on the 2nd passage must be passaged a third time for conformation. If a third passage is required, all controls must be passaged again.

**QUANTITATION OF TOTAL CULTURABLE VIRUS DATA SHEET**

**SAMPLE NUMBER:**

Sample	Number Replicates inoculated	Number with CPE	MPN/mL <sup>1</sup>	95% Confidence Limits	
				Lower	Upper
<b>Undiluted Samples</b>					
Subsample 1					
Subsample 2					
<b>Total Undiluted</b>					
<b>Subsample 2 results (Dilutions Required)</b>					
Undiluted					
1:5 Dilution					
1:25 Dilution					

<sup>1</sup>Use the values recorded in the Total Undiluted row to calculate the MPN/mL result and confidence limits when dilutions are not required. If dilutions are required, base the calculation upon the values recorded in the Undiluted, 1:5 Diluted and 1:25 Diluted rows for subsample 2. If higher dilutions are used for subsample 2, record the data from the three highest dilutions showing positive results and place the actual dilution amount in the sample column. The MPN/mL and 95% Confidence Limit values must be obtained using the computer program supplied by the U.S. EPA.

## SECTION IX. COLIPHAGE ASSAY

*This Section outlines the procedures for coliphage detection by plaque assay. It should be noted that the samples to be analyzed may contain pathogenic human enteric viruses. Laboratories performing the coliphage analysis are responsible for establishing an adequate safety plan.*

### ASSAY COMPONENTS

#### **Apparatus and Materials:**

1. Sterilizing filter — 0.45  $\mu\text{m}$  (Nuclepore Product No. 140667 or equivalent).

*Always pass about 10 mL of 1.5% beef extract through the filter just prior to use to minimize phage adsorption to the filter.*

2. Water bath set at  $44.5 \pm 1^\circ\text{C}$ .
3. Incubator set at  $36.5 \pm 1^\circ\text{C}$ .

#### **Media and Reagents:**

*The amount of media prepared may be increased proportionally to the number of samples to be analyzed.*

1. Saline-calcium solution — dissolve 8.5 g of NaCl and 0.22 g of  $\text{CaCl}_2$  in a total of 1 L of  $\text{dH}_2\text{O}$ . Dispense in 9 mL aliquots in  $16 \times 150$  mm screw-capped test tubes (Baxter Product No. T1356-6A or equivalent) and sterilize by autoclaving at  $121^\circ\text{C}$  for 15 min.
2. Tryptone agar slants — add 1.0 g tryptone (Difco Product No. 0123 or equivalent), 0.1 g yeast extract (Difco Product No. 0127 or equivalent), 0.1 g glucose, 0.8 g NaCl, 0.022 g  $\text{CaCl}_2$ , and 1.2 g of Bacto-agar (Difco Product No. 0140 or equivalent) to a total volume of 100 mL of  $\text{dH}_2\text{O}$  in a 250 mL flask. Dissolve by autoclaving at  $121^\circ\text{C}$  for 20 min and dispense 8 mL aliquots into  $16 \times 150$  mm test tubes with tube closures (Baxter Product Nos. T1311-16XX and T1291-16 or equivalent). Prepare slants by allowing the agar to solidify with the tubes at about a  $20^\circ$  angle. Slants may be stored at  $4^\circ\text{C}$  for up to two months.
3. Tryptone bottom agar — Prepare one day prior to sample analysis using the ingredients and concentrations listed for tryptone agar slants, except use 1.5 g of Bacto-agar. After autoclaving, pipet 15 mL aliquots aseptically into sterile  $100 \times 15$  mm petri plates and allow the agar to harden. Store the plates at  $4^\circ\text{C}$  overnight and warm to room temperature for 1 h before use.

4. Tryptone top agar — Prepare the day of sample analysis using the ingredients and concentrations listed for tryptone agar slants, except use 0.7 g of Bacto-agar. Autoclave and place in the  $44.5 \pm 1^\circ\text{C}$  water bath.
5. Tryptone broth — Prepare on the day prior to sample analysis as for tryptone agar slants, except without agar.
6. Beef extract V powder (BBL Microbiology Systems Product No. 97531) — prepare buffered 1.5% beef extract by dissolving 1.5 g of beef extract powder and 0.375 g of glycine (final glycine concentration = 0.05 M) in 90 mL of  $\text{dH}_2\text{O}$ . Adjust the pH to 7.0 - 7.5, if necessary, and bring the final volume to 100 mL with  $\text{dH}_2\text{O}$ . Autoclave at  $121^\circ\text{C}$  for 15 min and use at room temperature.  
*Beef extract solutions may be stored for one week at  $4^\circ\text{C}$  or for longer periods at  $-20^\circ\text{C}$ .*

### SAMPLE PROCESSING

Step 1. To measure the concentration of coliphage in water samples, use the coliphage sample prepared from the pH-adjusted 1MDS eluate as described in the **Elution Procedure in Part 2 of Section VII. Virus Monitoring Protocol.**

Step 2. Filter the coliphage sample through a  $0.45\ \mu\text{m}$  sterilizing filter.

Step 3. Assay ten 1 mL volumes each for somatic and male-specific coliphage within 24 h. Store the remaining eluate at  $4^\circ\text{C}$  to serve as a reserve in the event of sample contamination or high coliphage densities. If the coliphage density is expected or demonstrated to be greater than 100 PFU/mL, dilute the original or remaining eluate with a serial 1:10 dilution series into saline-calcium solutions. Assay the dilutions which will result in plaque counts of 100 or less.

### SOMATIC COLIPHAGE ASSAY

#### **Storage of *E. coli* C Host Culture for Somatic Coliphage Assay:**

1. For short term storage inoculate a *Escherichia coli* C (American Type Culture Collection Product No. 13706) host culture onto tryptone agar slants with a sterile inoculating loop by spreading the inoculum evenly over entire slant surface. Incubate the culture overnight at  $36.5 \pm 1^\circ\text{C}$ . Store at  $4^\circ\text{C}$  for up to two weeks.
2. For long term storage inoculate a 5-10 mL tube of tryptone broth with the host culture. Incubate the broth culture overnight at  $36.5 \pm 1^\circ\text{C}$ . Add 1/10th volume of sterile glycerol. Dispense into 1 mL aliquots in cryovials (Baxter Product No. T4050-8 or equivalent) and store at  $-70^\circ\text{C}$ .

### **Preparation of Host for Somatic Coliphage Assay:**

Step 1. Inoculate 5 mL of tryptone broth with *E. coli* C from a slant with an inoculating loop and incubate for 16 h at  $36.5 \pm 1^\circ\text{C}$ .

Step 2. Transfer 1.5 mL of the 16 h culture to 30 mL of tryptone broth in a 125 mL flask and incubate for 4 h at  $36.5 \pm 1^\circ\text{C}$  with gentle shaking. The amount of inoculum and broth used in this step can be proportionally altered according to need.

### **Preparation of $\phi\text{X174}$ Positive Control:**

Step 1. Rehydrate a stock culture of  $\phi\text{X174}$  (American Type Culture Collection Product No. 13706-B1) and store at  $4^\circ\text{C}$ .

Step 2. Prepare a 30 mL culture of *E. coli* C as described in section titled Preparation of Host for Somatic Coliphage Assay. Incubate for 2 h at  $36.5 \pm 1^\circ\text{C}$  with shaking. Add 1 mL of rehydrated phage stock and incubate for an additional 4 h at  $36.5 \pm 1^\circ\text{C}$ .

Step 3. Filter the culture through a  $0.45\ \mu\text{m}$  sterilizing filter.

Step 4. Prepare  $10^{-7}$ ,  $10^{-8}$  and  $10^{-9}$  dilutions of the filtrate using saline-calcium solution tubes.

*These dilutions should be sufficient for most  $\phi\text{X174}$  stocks. Some stocks may require higher or lower dilutions.*

Step 5. Add 1 mL of the  $10^{-9}$  dilution into each of five  $16 \times 150$  mm test tubes. Using the same pipette, add 1 mL of the  $10^{-8}$  dilution into each of five additional tubes and then 1 mL of the  $10^{-7}$  dilution into five tubes. Label the tubes with the appropriate dilution.

Step 6. Add 0.1 mL of the host culture into each of the 15 test tubes from Step 5.

Step 7. Add 3 mL of the melted tryptone top agar held in the  $44.5 \pm 1^\circ\text{C}$  water bath to one test tube at a time. Mix and immediately pour the contents of the tube over the bottom agar of a petri dish labeled with sample identification information. Rotate the dish to spread the suspension evenly over the surface of the bottom agar and place it onto a level surface to allow the agar to solidify.

Step 8. Incubate the inoculated plates at  $36.5 \pm 1^\circ\text{C}$  overnight and examine for plaques the following day.

Step 9. Count the number of plaques on each of the 15 plates (don't count plates giving plaque counts significantly more than 100). The five plates from one of the dilutions should

give plaque counts of about 20 to 100 plaques. Average the plaque counts on these five plates and multiply the result by the reciprocal of the dilution to obtain the titer of the undiluted stock.

Step 10. Dilute the filtrate to 30 to 80 PFU/mL in tryptone broth for use in a positive control in the coliphage assay. Store the original filtrate and the diluted positive control at 4°C.

*Before using the positive control for the 1st time, place 1 mL each into ten 16 × 150 mm test tubes and assay using Steps 6-8. Count the plaques on all plates and divide by 10. If the result is not 30 to 80, adjust the dilution of the positive control sample and assay again.*

### **Procedure for Somatic Coliphage Assay:**

Step 1. Sample preparation:

- a. Add 1 mL of the water eluate sample to be tested to each of ten 16 × 150 mm test tubes.
- b. Add 1 mL of buffered 1.5% beef extract to a 16 × 150 mm test tube for a negative control.
- c. Add 1 mL of the diluted  $\phi$ X174 positive control to another 16 × 150 mm test tube.

Step 2. Add 0.1 mL of the host culture to each test tube containing eluate or positive control.

Step 3. Add 3 mL of the melted tryptone top agar held in the  $44.5 \pm 1^\circ\text{C}$  water bath to one test tube at a time. Mix and immediately pour the contents of the tube over the bottom agar of a petri dish labeled with sample identification information. Tilt and rotate the dish to spread the suspension evenly over the surface of the bottom agar and place it onto a level surface to allow the agar to solidify.

Step 4. Incubate the inoculated plates at  $36.5 \pm 1^\circ\text{C}$  overnight and examine for plaques the following day.

Step 5. Count the total number of plaques on the ten plates receiving the water eluate.

Step 6. Somatic coliphage enumeration.

- a. Calculate the somatic coliphage titer ( $V_s$ ) in PFU per 100 L according to the formula:

$$V_s = \frac{100 \times P \times D \times E}{I \times C}$$

where P is the total number of plaques from Step 5, D is the reciprocal of the dilution made on the inoculum before plating ( $D = 1$  for undiluted samples) and E is the total volume of eluate recovered (from the Virus Data Sheet of the Total Culturable Virus Protocol). I is the total volume (in mL) of the eluate sample assayed on the ten plates. C is the amount of water sample filtered in liters (from the Sample Data Sheet of the Total Culturable Virus Protocol). Record the value of  $V_s$  in the ICR database.

- b. Count the plaques on the positive control plate. Maintain a record of the plaque count as a check on the virus sensitivity of the *E. coli* C host. Assay any water eluate samples again where the positive control counts are more than one log below their normal average.

#### MALE-SPECIFIC COLIPHAGE ASSAY

##### **Storage of *E. coli* Famp Host Culture for Male-Specific Coliphage Assay:<sup>1</sup>**

1. For short term storage inoculate a *Escherichia coli* Famp host culture onto tryptone agar slants with a sterile inoculating loop by spreading the inoculum evenly over entire slant surface. Incubate the culture overnight at  $36.5 \pm 1^\circ\text{C}$ . Store at  $4^\circ\text{C}$  for up to two weeks.
2. For long term storage inoculate a 5-10 mL tube of tryptone broth with the host culture. Incubate the broth culture overnight at  $36.5 \pm 1^\circ\text{C}$ . Add 1/10th volume of sterile glycerol. Dispense into 1 mL aliquots in cryovials (Baxter Product No. T4050-8 or equivalent) and store at  $-70^\circ\text{C}$ .

##### **Preparation of Host for Male-Specific Coliphage Assay:**

Step 1. Inoculate 5 mL of tryptone broth with *E. coli* Famp from a slant with an inoculating loop and incubate for 16 h at  $36.5 \pm 1^\circ\text{C}$ .

---

<sup>1</sup>The term "male-specific coliphage" refers to coliphages whose receptor sites are located on the bacterial F-pilus. The *E. coli* Famp strain to be used for ICR monitoring will be provided to virus analytical laboratories by a U.S. EPA contractor.



Step 2. Transfer 1.5 mL of the 16 h culture to 30 mL of tryptone broth in a 125 mL flask and incubate for 4 h at  $36.5 \pm 1^\circ\text{C}$  with gentle shaking. The amount of inoculum and broth used in this step can be proportionally altered according to need.

### **Preparation of MS2<sup>2</sup> Positive Control:**

Step 1. Rehydrate a stock culture of MS2 (American Type Culture Collection Product No. 15597-B1) and store at  $4^\circ\text{C}$ .

Step 2. Prepare a 30 mL culture of *E. coli* Famp as described in section titled Preparation of Host for Male-Specific Coliphage Assay. Incubate for 2 h at  $36.5 \pm 1^\circ\text{C}$  with shaking. Add 1 mL of rehydrated phage stock and incubate for an additional 4 h at  $36.5 \pm 1^\circ\text{C}$ .

Step 3. Filter the culture through a  $0.45 \mu\text{m}$  sterilizing filter.

Step 4. Prepare  $10^{-7}$ ,  $10^{-8}$  and  $10^{-9}$  dilutions of the filtrate using saline-calcium solution tubes.

*These dilutions should be sufficient for most MS2 stocks. Some stocks may require higher or lower dilutions.*

Step 5. Add 1 mL of the  $10^{-9}$  dilution into each of five  $16 \times 150$  mm test tubes. Using the same pipette, add 1 mL of the  $10^{-8}$  dilution into each of five additional tubes and then 1 mL of the  $10^{-7}$  dilution into five tubes. Label the tubes with the appropriate dilution.

Step 6. Add 0.1 mL of the host culture into each of the 15 test tubes from Step 5.

Step 7. Add 3 mL of the melted tryptone top agar held in the  $44.5 \pm 1^\circ\text{C}$  water bath to one test tube at a time. Mix and immediately pour the contents of the tube over the bottom agar of a petri dish labeled with sample identification information. Rotate the dish to spread the suspension evenly over the surface of the bottom agar and place it onto a level surface to allow the agar to solidify.

Step 8. Incubate the inoculated plates at  $36.5 \pm 1^\circ\text{C}$  overnight and examine for plaques the following day.

Step 9. Count the number of plaques on each of the 15 plates (don't count plates giving plaque counts significantly more than 100). The five plates from one of the dilutions should give plaque counts of about 20 to 100 plaques. Average the plaque counts on these five plates and multiply the result by the reciprocal of the dilution to obtain the titer of the undiluted stock.

---

<sup>2</sup>The MS2 positive control strain or a mixture of male-specific coliphage strains to be used for positive or quality controls will be supplied to virus analytical laboratories by a U.S. EPA contractor.

Step 10. Dilute the filtrate to 30 to 80 PFU/mL in tryptone broth for use in a positive control in the coliphage assay. Store the original filtrate and the diluted positive control at 4°C.

*Before using the positive control for the 1st time, place 1 mL each into ten 16 × 150 mm test tubes and assay using Steps 6-8. Count the plaques on all plates and divide by 10. If the result is not 30 to 80, adjust the dilution of the positive control sample and assay again.*

**Procedure for Male-Specific Coliphage Assay:**

Step 1. Sample preparation:

- a. Add 1 mL of the water eluate sample to be tested to each of ten 16 × 150 mm test tubes.
- b. Add 1 mL of buffered 1.5% beef extract to a 16 × 150 mm test tube for a negative control.
- c. Add 1 mL of the diluted MS2 positive control to another 16 × 150 mm test tube.

Step 2. Add 0.1 mL of the host culture to each test tube containing eluate or positive control.

Step 3. Add 3 mL of the melted tryptone top agar held in the  $44.5 \pm 1^\circ\text{C}$  water bath to one test tube at a time. Mix and immediately pour the contents of the tube over the bottom agar of a petri dish labeled with sample identification information. Tilt and rotate the dish to spread the suspension evenly over the surface of the bottom agar and place it onto a level surface to allow the agar to solidify.

Step 4. Incubate the inoculated plates at  $36.5 \pm 1^\circ\text{C}$  overnight and examine for plaques the following day.

Step 5. Count the total number of plaques on the ten plates receiving the water eluate.

Step 6. Male Specific coliphage enumeration.

a. Calculate the male specific coliphage titer ( $V_M$ ) in PFU per 100 L according to the formula:

$$V_M = \frac{100 \times P \times D \times E}{I \times C}$$

where P is the total number of plaques from Step 5, D is the reciprocal of the dilution made on the inoculum before plating ( $D = 1$  for undiluted samples) and E is the total volume of eluate recovered (from the Virus Data Sheet of the Total Culturable Virus Protocol). I is the total volume (in mL) of the eluate sample assayed on the ten plates. C is the amount of water sample filtered in liters (from the Sample Data Sheet of the Total Culturable Virus Protocol). Record the value of  $V_M$  in the ICR database.

b. Count the plaques on the positive control plate. Maintain a record of the plaque count as a check on the virus sensitivity of the bacterial host. Assay any water eluate samples again where the positive control counts are more than one log below their normal average.

## SECTION X. MEMBRANE FILTER METHOD FOR *E. coli*

1. **Citation:** METHOD 1103.1, 1985
2. **Scope**
  - 2.1 This method describes a membrane filter (MF) procedure for the detection and enumeration of *Escherichia coli* (*E. coli*). Because the bacterium is a natural inhabitant only of the intestinal tract of warm-blooded animals, its presence in water samples is an indication of fecal pollution and the possible presence of enteric pathogens.
  - 2.2 The *E. coli* test is used as a measure of recreational water quality. Epidemiological studies have led to the development of criteria which can be used to promulgate recreational water standards based on established relationships between health effects and water quality. The significance of finding *E. coli* in recreational water samples is the direct relationship between the density of *E. coli* and the risk of gastrointestinal illness associated with swimming in the water (1).
  - 2.3 The test for *E. coli* can be applied to fresh, estuarine and marine waters.
  - 2.4 Since a wide range of sample volumes or dilutions thereof can be analyzed by the MF technique, a wide range of *E. coli* levels in water can be detected and enumerated.
3. **Summary** - The MF method provides a direct count of bacteria in water based on the development of colonies on the surface of the membrane filter (2). A water sample is filtered through the membrane which retains the bacteria. After filtration, the membrane containing the bacterial cells is placed on a selective and differential medium, M-TEC, incubated at 35°C for 2 h to resuscitate injured or stressed bacteria, and then incubated at 44.5°C for 22 h. Following incubation, the filter is transferred to a filter pad saturated with urea substrate. After 15 min, yellow or yellow-brown colonies are counted with the aid of a fluorescent lamp and a magnifying lens.
4. **Definition** - In this method, *E. coli* are those bacteria which produce yellow or yellow-brown colonies on a filter pad saturated with urea substrate broth after primary culturing on M-TEC medium.
5. **Interferences** - Water samples containing colloidal or suspended particulate material can clog the membrane filter and prevent filtration, or cause spreading of bacterial colonies which could interfere with identification of target colonies.

## **6. Safety Precautions**

- 6.1 The analyst/technician must know and observe the normal safety procedures required in a microbiology laboratory while preparing, using, and disposing of cultures, reagents and materials and while operating sterilization equipment.
- 6.2 Mouth-pipetting is prohibited.

## **7. Apparatus and Equipment**

- 7.1 Glass lens, 2-5X magnification, or stereoscopic microscope.
- 7.2 Lamp with cool, white fluorescent tube and diffuser.
- 7.3 Hand tally or electronic counting device.
- 7.4 Pipet container, stainless steel, aluminum, or borosilicate glass, for glass pipets.
- 7.5 Pipets, sterile, T.D. bacteriological or Mohr, glass or plastic, of appropriate volume.
- 7.6 Graduated cylinders, covered with aluminum foil or kraft paper and sterile.
- 7.7 Membrane filtration units (filter base and funnel), glass, plastic or stainless steel, wrapped with aluminum foil or kraft paper and sterile.
- 7.8 Ultraviolet unit for sterilizing the filter funnel between filtrations (optional).
- 7.9 Line vacuum, electric vacuum pump, or aspirator for use as a vacuum source. In an emergency, or in the field, a hand pump, or a syringe equipped with a check valve to prevent the return flow of air, can be used.
- 7.10 Flask, filter vacuum, usually 1 L, with appropriate tubing. A filter manifold to hold a number of filter bases is optional.
- 7.11 Flask for safety trap, placed between the filter flask and the vacuum source.
- 7.12 Forceps, straight or curved, with smooth tips to handle filters without damage.
- 7.13 Ethanol, methanol or isopropanol in a small, wide-mouth container, for flame-sterilizing forceps.
- 7.14 Burner, Bunsen or Fisher type, or electric incinerator unit for sterilizing inoculation loops.

- 7.15 Thermometer, checked against a National Institute of Science & Technology (NIST) certified thermometer, or one traceable to an NIST thermometer.
- 7.16 Petri dishes, sterile, plastic, 50 × 12 mm, with tight-fitting lids, or 60 × 15 mm, glass or plastic, with loose-fitting lids. 100 × 15 mm dishes may also be used.
- 7.17 Bottles, milk dilution, borosilicate glass, screw-cap with neoprene liners, marked at 99 mL for 1-100 dilutions. Dilution bottles marked at 90 mL, or tubes marked at 9 mL may be used for 1-10 dilutions.
- 7.18 Flasks, borosilicate glass, screw-cap, 250-2000 mL volume.
- 7.19 Membrane filters, sterile, white grid marked, 47 mm diameter, with  $0.45 \pm 0.02 \mu\text{m}$  pore size.
- 7.20 Absorbent pads, sterile, 47 mm diameter (usually supplied with membrane filters).
- 7.21 Inoculation loops, at least 3 mm diameter, and needles, nichrome and platinum wire, 26 B & S gauge, in suitable holders. Disposable applicator sticks or plastic loops are alternatives to inoculation loops. **Note:** A platinum loop is required for the cytochrome oxidase test in 15.3.
- 7.22 Incubator maintained at  $35 \pm 0.5^\circ\text{C}$ , with approximately 90 percent humidity if loose-lidded petri dishes are used.
- 7.23 Waterbath incubator maintained at  $44.5 \pm 0.2^\circ\text{C}$ .
- 7.24 Waterbath maintained at 44-46°C for tempering agar.
- 7.25 Test tubes, 150 × 20 mm, borosilicate glass or plastic.
- 7.26 Test tubes, 75 × 10 mm, borosilicate glass.
- 7.27 Test tube caps, aluminum or autoclavable plastic, for 20 mm diameter test tubes.
- 7.28 Test tubes, screw-cap, 125 × 16 mm or other appropriate size.
- 7.29 Filter paper.

## 8. Reagents and Materials

8.1 **Purity of Reagents:** Reagent grade chemicals shall be used in all tests. Unless otherwise indicated, reagents shall conform to the specifications of the **Committee on Analytical Reagents of the American Chemical Society** (3). The agar used in preparation of culture media must be of microbiological grade.

8.2 Whenever possible, use commercial culture media as a means of quality control.

8.3 **Purity of Water:** Reagent water conforming to Specification D1193, Type II water, **ASTM Annual Book of Standards** (4).

### 8.4 **Buffered Dilution Water**

#### 8.4.1 **Composition:**

Sodium Dihydrogen Phosphate	0.58	g
Sodium Monohydrogen Phosphate	2.50	g
Sodium Chloride	8.50	g

8.4.2 **Preparation:** Dissolve the ingredients in 1 L of reagent water in a flask and dispense in appropriate amounts for dilutions in screw-cap bottles or culture tubes, and/or into containers for use as rinse water. Autoclave after preparation at 121 °C (15 lb pressure) for 15 min. Final pH should be 7.4 ± 0.2.

### 8.5 **M-TEC Agar** (Difco 0334-15-0)

#### 8.5.1 **Composition:**

Proteose Peptone #3	5.0	g
Yeast Extract	3.0	g
Lactose	10.0	g
NaCl	7.5	g
Dipotassium Phosphate	3.3	g
Monopotassium Phosphate	1.0	g
Sodium Lauryl Sulfate	0.2	g
Sodium Desoxycholate	0.1	g
Brom Cresol Purple	0.08	g
Brom Phenol Red	0.08	g
Agar	15.0	g

8.5.2 **Preparation:** Add 45.26 g of M-TEC medium to 1 L of reagent water in a flask and heat to boiling, until ingredients dissolve. Autoclave at 121 °C (15 lb pressure) for 15 min. and cool in a 44-46 °C waterbath. Pour the

medium into each 50 × 10 mm culture dish to a 4-5 mm depth (approximately 4-6 mL) and allow to solidify. Final pH should be 7.3 ± 0.2. Store in a refrigerator.

## 8.6 Urea Substrate Medium

### 8.6.1 Composition:

Urea	2.0	g
Phenol red	0.01	g

8.6.2 **Preparation:** Add dry ingredients to 100 mL reagent water in a flask. Stir to dissolve and adjust to pH 5.0 with a few drops of 1N HCl. The substrate solution should be a straw-yellow color at this pH.

## 8.7 Nutrient Agar (Difco 0001-02, BBL 11471)

### 8.7.1 Composition:

Peptone	5.0	g
Beef Extract	3.0	g
Agar	15.0	g

8.7.2 **Preparation:** Add 23 g of nutrient agar ingredients to 1 L of reagent water and mix well. Heat in boiling waterbath to dissolve the agar completely. Dispense in screw-cap tubes, bottles or flasks and autoclave at 121 °C (15 lb pressure) for 15 min. Remove tubes and slant. The final pH should be 6.8 ± 0.2.

## 8.8 Tryptic Soy Broth (Difco 0370-02) or Trypticase Soy Broth (BBL 12464)

### 8.8.1 Composition:

Tryptone or Trypticase	17.0	g
Soytone or Phytone	3.0	g
Sodium Chloride	5.0	g
Dextrose	2.5	g
Dipotassium Phosphate	2.5	g

8.8.2 **Preparation:** Add 30 g of Tryptic (Trypticase) soy broth to 1 L of reagent water. Warm the broth and mix gently to dissolve the medium completely. Dispense in screw-cap tubes and autoclave at 121 °C (15 lb pressure) for 15 min. The final pH should be 7.3 ± 0.2.



## 8.9 Simmons' Citrate Agar (BBL 11619, Difco 0091-02)

### 8.9.1 Composition

Magnesium Sulfate	0.2	g
Monoammonium Phosphate	1.0	g
Dipotassium Phosphate	1.0	g
Sodium Citrate	2.0	g
Sodium Chloride	5.0	g
Brom Thymol Blue	0.08	g
Agar	15.0	g

8.9.2 **Preparation:** Add 24.28 g of Simmons' citrate agar to 1 L of reagent water. Heat in boiling waterbath with mixing for complete solution. Dispense in screw-cap tubes and sterilize at 121°C (15 lb pressure) for 15 min. Cool tubes as slants. The final pH should be  $6.8 \pm 0.2$ .

## 8.10 Tryptone (Difco 0123-02) or Trypticase Peptone (BBL 11920) Broth

### 8.10.1 Composition:

Tryptone or Trypticase peptone	10.0	g
--------------------------------	------	---

8.10.2 **Preparation:** Add 10 g of tryptone or trypticase peptone to 900 mL of reagent water and heat with mixing until dissolved. Bring solution to 1000 mL in a graduate or flask. Dispense in five mL volumes in tubes and autoclave at 121°C (15 lb pressure) for 15 min. The final pH should be  $7.2 \pm 0.2$ .

## 8.11 EC Broth (Difco 0314-02) or EC Broth (BBL 12432)

### 8.11.1 Composition:

Tryptose or Trypticase Peptone	20.0	g
Lactose	5.0	g
Bile Salts No. 3 or Bile Salts Mixture	1.5	g
Dipotassium Phosphate	4.0	g
Monopotassium Phosphate	1.5	g
Sodium Chloride	5.0	g

8.11.2 **Preparation:** Add 37 g of EC medium to 1 L of reagent water and warm to dissolve completely. Dispense into fermentation tubes (150 × 20 mm tubes containing inverted 75 × 10 mm vials). Sterilize at 121°C (15 lb pressure) for 15 min. The final pH should be  $6.9 \pm 0.2$ .

- 8.12 **Cytochrome Oxidase Reagent:** N, N, N<sup>1</sup>, N<sup>1</sup> tetramethyl-p-phenylenediamine dihydrochloride, 1% aqueous solution.
- 8.13 **Kovacs' Indole Reagent:** Dissolve 10 g p-dimethylaminobenzaldehyde in 150 mL amyl or isoamyl alcohol and then slowly add 50 mL concentrated hydrochloric acid and mix.

## 9. Sample Collection, Preservation and Holding Times

9.1 Sampling procedures are described in detail in the **USEPA Microbiology Methods Manual**, Section II, A (5). Adherence to sample preservation procedures and holding time limits is critical to the production of valid data. Samples not collected according to these rules should not be analyzed.

9.1.1 **Storage Temperature and Handling Conditions:** Ice or refrigerate water samples at a temperature of 1-4°C during transit to the laboratory. Use insulated containers to assure proper maintenance of storage temperature. Take care that sample bottles are not totally immersed in water during transit or storage.

9.1.2 **Holding Time Limitations:** Examine samples as soon as possible after collection. Do not hold samples longer than 8 h between collection and initiation of analyses.

## 10. Calibration and Standardization

- 10.1 Check temperatures in incubators daily to insure operation within stated limits.
- 10.2 Check thermometers at least annually against an NIST certified thermometer or one traceable to NIST. Check mercury columns for breaks.

## 11. Quality Control

11.1 See recommendations on quality control for microbiological analyses in the **USEPA Microbiology Methods Manual**, Part IV, C (5).

## 12. Procedures

- 12.1 Prepare the M-TEC agar and urea substrate as directed in **Sections 8.5 and 8.6**.
- 12.2 Mark the petri dishes and report forms with sample identification and sample volumes.

- 12.3 Place a sterile membrane filter on the filter base, grid-side up and attach the funnel to the base; the membrane filter is now held between the funnel and the base.
- 12.4 Shake the sample bottle vigorously about 25 times to distribute the bacteria uniformly and measure the desired volume of sample or dilution into the funnel.
- 12.5 For ambient surface waters and waste waters, select sample volumes based on previous knowledge of pollution level, to produce 20-80 *E. coli* colonies on the membranes. Sample volumes of 1-100 mL are normally tested at half-log intervals.
- 12.6 Smaller sample size or sample dilutions can be used to minimize the interference of turbidity or high bacterial densities. Multiple volumes of the same sample dilution may be filtered and the results combined.
- 12.7 Filter the sample and rinse the sides of the funnel at least twice with 20-30 mL of sterile rinse water. Turn off the vacuum and remove the funnel from the filter base.
- 12.8 Use sterile forceps to aseptically remove the membrane filter from the filter base and roll it onto the M-TEC agar to avoid the formation of bubbles between the membrane and the agar surface. Reseat the membrane, if bubbles occur. Close the dish, invert, and incubate at 35°C for 2 h.
- 12.9 After 2 h incubation at 35°C, transfer the plates to Whirl-Pak bags, seal, and place inverted in a 44.5°C waterbath for 22-24 h.
- 12.10 After 22-24 h, remove the dishes from the waterbath. Place absorbent pads in new petri dishes or the lids of the same petri dishes, and saturate with urea broth. Aseptically transfer the membranes to absorbent pads saturated with urea substrate and hold at room temperature.
- 12.11 After 15-20 min. incubation on the urea substrate at room temperature, count and record the number of yellow or yellow-brown colonies on those membrane filters ideally containing 20-80 colonies.

### 13. Calculation of Results

- 13.1 Select the membrane filter with the number of colonies within the acceptable range (20-80) and calculate the count per 100 mL according to the general formula:

$$E. coli/100 \text{ mL} = \frac{\text{No. } E. coli \text{ Colonies Counted}}{\text{Volume in mL of Sample Filtered}} \times 100 \text{ mL}$$

- 13.2 See general counting rules in the **USEPA Microbiology Methods Manual**, Part II, C, 3.5 (5).

### 14. Reporting Results

- 14.1 Report the results as *E. coli* per 100 mL of sample.

### 15. Verification Procedure

- 15.1 Yellow or yellow-brown colonies from the urease test can be verified as *E. coli*. Verification of colonies may be required in evidence gathering, and is also recommended as a QC procedure with initial use of the test and with changes in sample sites, lots of commercial media or major ingredients in media compounded in the laboratory. The verification procedure follows:
- 15.1.1 Using a sterile inoculation loop, transfer growth from the centers of at least 10 well-isolated typical colonies to nutrient agar plates or slants and to Tryptic (Trypticase) soy broth. Incubate the agar and broth cultures for 24 h at 35°C.
- 15.1.2 After incubation remove a generous portion of material from the nutrient agar **with a platinum loop** and deposit on the surface of filter paper that has been saturated with cytochrome oxidase reagent prepared fresh that day. A positive test is indicated within 15 s by the development of a deep purple color where the bacteria were deposited.
- 15.1.3 Transfer growth from the Tryptic (Trypticase) soy broth to Simmons' citrate agar, Tryptone (Trypticase peptone) broth and EC broth in a fermentation tube. Incubate the Simmons' citrate agar for 24 h and Tryptone (Trypticase peptone) broth for 48 h at 35°C. Incubate the EC broth at 44.5°C in a waterbath for 24 h. The water level must be above the level of the EC broth in the tube. Add one-half mL of Kovacs' indole reagent to the 48 h Tryptone (Trypticase peptone) broth culture and shake the tube gently. A positive test for indole is indicated by a deep red color which develops in

the alcohol layer. *E. coli* is EC gas positive, indole positive, oxidase negative, and does not grow on citrate medium.

## 16. Precision and Bias

### 16.1 Performance Characteristics

- 16.1.1 **Precision** - The degree of agreement of repeated measurements of the same parameter expressed quantitatively as the standard deviation or as the 95% confidence limits of the mean computed from the results of a series of controlled determinations. The M-TEC method precision was found to be fairly representative of what would be expected from counts with a Poisson distribution (2).
- 16.1.2 **Bias** - The persistent positive or negative deviation of the average value of the method from the assumed or accepted true value. The bias of the M-TEC method has been reported to be -2% of the true value (2).
- 16.1.3 **Specificity** - The ability of a method to select and/or distinguish the target bacteria under test from other bacteria in the same water sample. The specificity characteristic of a method is usually reported as the percent of false-positive and false-negative results. The false-positive rate reported for M-TEC medium averaged 9% for marine and fresh water samples. Less than 1% of the *E. coli* colonies observed gave a false-negative reaction (2).
- 16.1.4 **Upper Counting Limit (UCL)** - That colony count above which there is an unacceptable counting error. The error may be due to overcrowding or antibiotics. The UCL for *E. coli* on M-TEC medium has been reported as 80 colonies per filter (2).

### 16.2 Collaborative Study Data

- 16.2.1 A collaborative study was conducted among eleven volunteer laboratories, each with two analysts who independently tested local fresh and marine recreational waters and sewage treatment plant effluent samples, in duplicate. The data were reported to the **Environmental Monitoring and Support Laboratory - Cincinnati, Ohio, U.S. Environmental Protection Agency**, for statistical calculations.
- 16.2.2 The results of the study are shown in **Figure X-1** where  $S_o$  equals standard deviation among replicate counts from a single analyst and  $S_b$  equals standard deviation between means of duplicates from analysts in the same

**Figure X-1. Precision Estimates for *E. coli* in Water by the Membrane Filter M-TEC Method**

$S_o$  = Standard Deviation among Replicate Counts from a Single Analyst  
 $S_B$  = Standard Deviation between the Means of Duplicate Counts by Analysts  
in the Same Laboratory

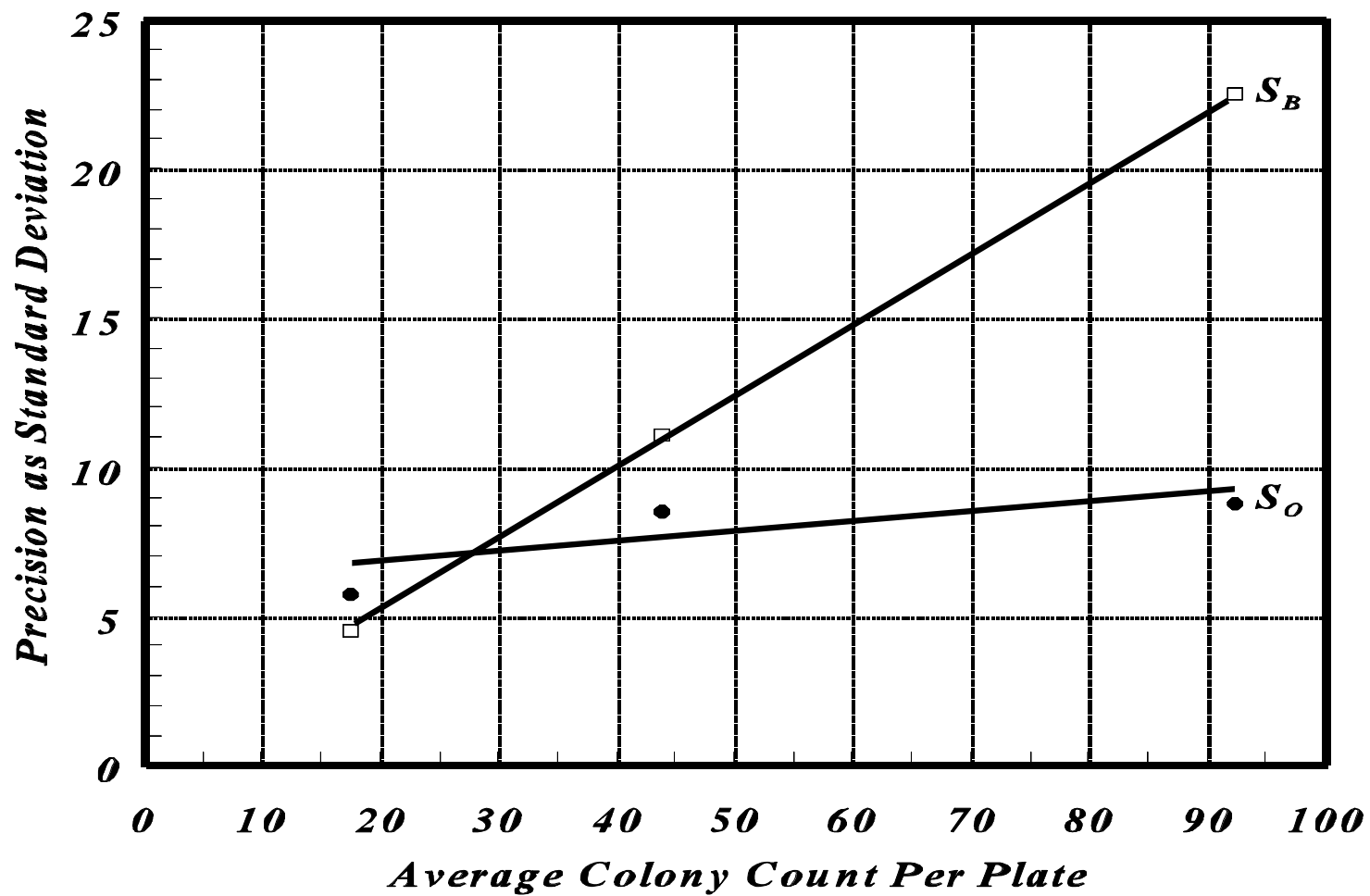

laboratory. The precision estimates from this study did not show any difference among the water types analyzed.

- 16.2.3 The precision of the method can be generalized as:  
 $S_o = 0.028 \text{ count/100 mL} + 6.11$  (dilution factor) and  
 $S_b = 0.233 \text{ count/100 mL} + 0.82$  (dilution factor), where the

$$\text{dilution factor} = \frac{100}{\text{VOLUME OF ORIGINAL SAMPLE FILTERED}}$$

- 16.2.4 Because of the instability of microbial populations in water samples, each laboratory analyzed its own sample series and no full measure of recovery or bias was possible. However, all laboratories analyzed a single surrogate sample prepared from a freeze-dried culture of *E. coli*. The mean count ( $\bar{x}$ ) and the overall standard deviation of the counts ( $S_t$ ) (which includes the variability among laboratories for this standardized *E. coli* sample) were 31.6 colonies/membrane and 7.61 colonies/membrane, respectively.

## 17. REFERENCES

1. Cabelli, V.J., A.P. Dufour, M.A. Levin, L.J. McCabe, and P.W. Haberman. 1979. Relationship of Microbial Indicators to Health Effects at Marine Bathing Beaches. *Amer. Jour. Public Health* **69**:690-696.
2. Dufour, A.P., E. Strickland, and V.J. Cabelli. 1981. Membrane Filter Method for Enumerating *Escherichia coli*. *Appl. and Environ. Microbiol.* **41**:1152-1158.
3. Reagent Chemicals. 1981. American Chemical Society Specifications, 6th Edition, Am. Chem. Soc., Washington, D.C. For suggestions on the testing of reagents not listed by the American Chemical Society, see Reagent Chemicals and Standards. 1967. Joseph Rosin, D. Van Nostrand Co., Inc., Princeton, N.J., and the United States Pharmacopeia, Nineteenth Edition. 1974. United States Pharmacopeial Convention, Inc., Rockville, Md.
4. Annual Book of ASTM Standards. 1985. Vol. 1101, Water, American Society for Testing and Materials, Philadelphia, PA.
5. Bordner, R., J.A. Winter and P.V. Scarpino (eds.). 1978. Microbiological Methods for Monitoring the Environment. Water and Wastes, EPA-600/8-78-077, U.S. Environmental Protection Agency, Office of Research and Development, Environmental Monitoring Support Laboratory - Cincinnati, Cincinnati, Ohio.

## SECTION XI. MEMBRANE FILTER METHOD FOR *C. perfringens*

### 1. Scope and Application

- 1.1 This procedure enumerates *Clostridium perfringens* spores from surface and drinking water. Since *C. perfringens* is present in large numbers in human and animal wastes and its spores are resistant to wastewater treatment practices, extremes in temperature and environmental stress, it is an indicator of present fecal contamination as well as a conservative tracer of past fecal contamination. Some investigators have proposed *C. perfringens* as an indicator of the presence and the density of pathogenic viruses and possibly other microorganisms.
- 1.2 It is the user's responsibility to insure the validity of this method for untested matrices.

2. **Summary of Method** - An appropriate volume of water sample is passed through a membrane filter that retains the bacteria present in the sample. The membrane filter is placed on mCP agar and incubated anaerobically for 24 h at 44.5°C using a medium modified by Armon and Payment from Bisson and Cabelli (1,2). Upon exposure to ammonium hydroxide, the yellow straw-colored *C. perfringens* colonies turn dark pink to magenta and are counted as presumptive *C. perfringens*. Because of the selectivity of the mCP medium, a presumptive count is normally reported for routine monitoring purposes. Verification is not required for ICR monitoring, but if desired, colonies are confirmed by anaerobic growth in thioglycollate, a positive gram stain reaction and stormy fermentation of iron milk. The mCP counts are adjusted based on the percent confirmation. This method was originally prepared by Irwin Katz, U.S. EPA Region 2 for ASTM Subcommittee D19.24, Water Microbiology.

### 3. Definitions

- 3.1 *C. perfringens* - An obligate anaerobic gram-positive, spore forming, non-motile bacillus that ferments lactose with stormy gas production and ferments sucrose but does not ferment cellobiose. *C. perfringens* produces acid phosphatase and also produces exotoxins which cause gas gangrene and gastroenteritis.
- 3.2 Spores - *C. perfringens* produces single oval subterminal spores less than 1 µm in diameter during adverse conditions. Sporulation can also occur in the intestinal tract. The endospore that develops is a highly refractile body formed within the cell. Spores are resistant to heat, drying and chemical disinfectants, which would kill the vegetative cells of *C. perfringens*. This resistance to unfavorable conditions preserves the organisms for long periods of time.



#### **4. Interferences**

- 4.1 Waters containing sediment or large quantities of colloidal or suspended materials such as iron, manganese, alum floc or algae can clog the filter pores and prevent filtration, or can cause the development of spreading bacterial colonies that mask other colonies and prevent accurate counting.
- 4.2 When bacterial densities are high, a smaller sample volume or sample dilution can be filtered to minimize the interference of turbidity or high background (non-target) bacterial densities. Replicates of smaller sample volumes or dilutions of sample may be filtered and the results combined. However, the membrane filter technique may not be applicable to highly turbid waters with low *Clostridium* densities.
- 4.3 Toxic materials such as metals, phenols, acids, caustics, chloramines, and other disinfection by-products may also adversely affect recovery of *Clostridium* vegetative cells on the membrane filter. Although most probable number (MPN) methods are not usually expected to generate results comparable to membrane filter methods, an MPN method should be considered as an alternative procedure if the membrane filter method is not useable for these samples (3).
- 4.4 Some lots of membrane filters produce low recoveries or poor differentiation of target and non-target colonies due to toxicity, chemical composition, or structural defects. Quality control checks should be made on new lots of membranes (4).

#### **5. Health and Safety**

- 5.1 This method does not address all safety problems associated with its use. It is the responsibility of the user to establish appropriate safety and health practices and determine regulatory limitations prior to use.
- 5.2 The analyst/technician must know and observe normal good laboratory practices and safety procedures required in a microbiology laboratory while preparing, using and disposing of cultures, reagents and materials and while operating sterilizers and other equipment and instrumentation.
- 5.3 Mouth-pipetting is not permitted.

## 6. Instruments, Equipment and Supplies

- 6.1 Sample container, sterile, non-toxic glass or rigid plastic with screw cap, or plastic bag, minimum of 125 mL capacity.
- 6.2 Pipet container, stainless steel, or aluminum, for sterilization and storage of glass pipets.
- 6.3 Pipets, sterile T.D. bacteriological or Mohr, glass or plastic, of appropriate volumes.
- 6.4 Graduated cylinders, 100 to 1000 mL, tops are covered with aluminum foil or kraft paper and sterilized.
- 6.5 Bottles, milk dilution, borosilicate glass or non-toxic heat stable plastic, screw-cap with neoprene liners, marked at 99 mL for 1:100 dilutions. Dilution bottles marked at 90 mL or tubes marked at 9 mL may be used for 1:10 dilutions.
- 6.6 Membrane filtration units, (filter base and funnel), glass, plastic or stainless steel, wrapped with aluminum foil or kraft paper and sterilized.
- 6.7 Membrane Filters - sterile, white, grid marked, 47 mm diameter, with  $0.45 \pm 0.02$   $\mu\text{m}$  pore size or other pore sizes for which the manufacturer provides data demonstrating equivalency.
- 6.8 Ultraviolet unit for disinfecting the filter funnel between filtrations in a series (optional).
- 6.9 Line vacuum, electric vacuum pump or aspirator as a vacuum source.
- 6.10 Flask, vacuum, usually 1 L, with appropriate tubing, to hold filter base. Filter manifolds to hold a number of filter bases are optional.
- 6.11 Flask, safety trap, placed between the filter flask and the vacuum source.
- 6.12 Forceps, straight or curved, with smooth tips to permit handling of filters without damage.
- 6.13 Petri plates, plastic or glass,  $50 \times 9$  mm, with tight-fitting lids, or  $60 \times 12$  mm, with loose fitting lids (dimensions are nominal).
- 6.14 Test Tubes,  $20 \times 150$  mm, borosilicate glass or disposable plastic.
- 6.15 Caps, aluminum or autoclavable plastic, for  $20 \times 150$  mm test tubes.

- 6.16 Test Tubes, screw cap, 16 × 125 mm or other appropriate size.
- 6.17 Inoculation loops, 3 mm diameter, and needles, nichrome or platinum wire, 26 B & S gauge, in suitable holders. Sterile disposable applicator sticks or plastic loops are acceptable alternatives to inoculation loops.
- 6.18 Thermometers, 0-50°C, graduated to 0.2 degrees, and 0-100°C for heat shock which has been checked against the appropriate National Institute of Standards and Technology (NIST) certified thermometer, or against a thermometer traceable to NIST.
- 6.19 Waterbath, that maintains 46-48°C for tempering agar.
- 6.20 Waterbath with gable cover that maintains 60°C ± 0.5°C for heat shocking samples.
- 6.21 Anaerobic system (anaerobic jar, reaction chamber, hydrogen/carbon dioxide disposable generator and anaerobic indicator), or any other system capable of producing the appropriate anaerobic conditions to support the growth of the organisms<sup>1</sup>.
- 6.22 Filter Paper, circular, 11 cm, Whatman 40 or 110, or equivalent, for separation of mCP agar plates during anaerobic incubation.
- 6.23 Incubator, that maintains 44.5°C ± 0.2°C and is large enough to hold the anaerobic chamber.
- 6.24 Incubator, Water Bath, that maintains 44.5°C ± 0.2°C for incubation of Iron Milk Medium.
- 6.25 Microscope, stereoscopic, wide-field type, with magnification of 10 to 15X.
- 6.26 Microscope lamp, that produces diffuse light from a cool white fluorescent or tungsten lamp adjusted to give maximum visibility.
- 6.27 Counting device, hand tally or electronic.

---

<sup>1</sup>BBL 60460 or BBL 60466 GASPAC Anaerobic System with BBL 70308 Disposable Hydrogen and Carbon Dioxide Generator Envelopes, BBL Microbiological Systems, Cockeysville, MD 21030, or equivalent.

6.28 Sonication unit, to aid in dissolving reagents.<sup>2</sup>

## 7. Reagents, Standards and Media

7.1 **Purity of Reagents** - Use reagent grade chemicals in all tests. Unless otherwise indicated, all reagents must conform to the specifications of the Committee on Analytical Reagents of the American Chemical Society where such specifications are available (5). Other grades may be used, provided it is first ascertained that the reagent is of sufficiently high purity to permit its use without lessening the accuracy of the determination. Use microbiological grade agar in preparation of culture media. Whenever possible, use commercial culture media as a means of improved quality control.

7.2 **Purity of Water** - Unless otherwise indicated, references to water mean reagent water as defined by Type II of Specification D1193 (6).

### 7.3 **Buffered Dilution and Rinse Water**

#### 7.3.1 **Phosphate Buffer Dilution Water**

7.3.1.1 **Stock Phosphate Buffer Solution** - Dissolve 34.0 g of potassium dihydrogen phosphate ( $\text{KH}_2\text{PO}_4$ ) in 500 mL of water. Adjust pH to 7.2 with 1 N NaOH and bring to 1000 mL with water. Dispense aseptically into screw-cap bottles and autoclave for 15 min at 121 °C. Alternatively, sterilize by filtration through a 0.2  $\mu\text{m}$  pore membrane filter and dispense aseptically into sterile screw-cap bottles. Store in refrigerator and handle aseptically. If cloudiness, a marked change in pH, or other evidence of contamination appears, discard the stock. Confirm that pH is  $7.2 \pm 0.5$  before use.

7.3.1.2 **Magnesium Chloride Solution** - Dissolve 81.4 g of hexahydrate magnesium chloride ( $\text{MgCl}_2 \cdot 6\text{H}_2\text{O}$ ) in 1000 mL of water. Mix well and sterilize by filtration or autoclave for 15 min at 121 °C. Store in refrigerator and handle aseptically. If cloudiness, or other evidence of contamination occurs, discard the stock solution.

7.3.1.3 **Phosphate Buffered Dilution Water** - Add 1.25 mL of stock phosphate buffer solution and 5 mL of magnesium chloride solution to 1000 mL of water in a volumetric flask and mix well. Dispense dilution water in amounts which will provide  $99 \pm 2$  mL after sterili-

---

<sup>2</sup>Bronson Sonifier, 500 W, or Tekmar Sonic Disrupter, 500 W with 3 mm tip set at 18 W, or equivalent.

zation in screw-cap dilution bottles, or in larger volume containers for use as rinse water. Autoclave dilution bottles for 15 min at 121°C. Autoclave larger volumes for longer periods as appropriate. Alternatively, sterilize by filtration through a sterile 0.2 µm pore membrane filter unit and dispense aseptically into sterile screw-cap bottles.

- 7.3.2 **Peptone Dilution and Rinse Water** - Dissolve 1.0 g of peptone<sup>3</sup> in 100 mL of water, and bring to 1000 mL with water. Dispense in screw-cap bottles in volumes to produce  $99 \pm 2$  mL after autoclaving. Autoclave for 15 min. at 121°C. Final pH should be 6.8 - 7.0. Adjust as necessary.
- 7.4 **Ethanol** - 95%, pure, for flame-sterilization of forceps and for preparation of acetone alcohol for gram stain.
- 7.5 **Ammonium Hydroxide Solution** (29.2% NH<sub>4</sub>OH) - commercially available.
- 7.6 **Ferric Chloride Solution** - Weigh out 4.5 g of FeCl<sub>3</sub>·6H<sub>2</sub>O and dissolve in 100 mL of water. Filter sterilize and store in refrigerator.
- 7.7 **Phenolphthalein diphosphate Solution** - Weigh out 0.5 g of phenolphthalein diphosphate and dissolve in 100 mL of water. Filter sterilize and store in refrigerator.
- 7.8 **Indoxyl β-D Glucoside Solution** - Weigh out 0.06 g of Indoxyl β-D Glucoside and dissolve in 80 mL of water (0.075 solution). Sonicator (item 6.28) can be used to speed dissolution. Filter-sterilize and use in 7.9.2.
- 7.9 **Modified mCP Agar** (1)
- 7.9.1 **Composition/L**
- |                                      |      |   |
|--------------------------------------|------|---|
| Tryptose                             | 30.0 | g |
| Yeast Extract                        | 20.0 | g |
| Sucrose                              | 5.0  | g |
| L-cysteine Hydrochloride             | 1.0  | g |
| MgSO <sub>4</sub> ·7H <sub>2</sub> O | 0.1  | g |
| Bromcresol Purple                    | 0.04 | g |
| Agar                                 | 15.0 | g |
- 7.9.2 **Preparation of Modified mCP Agar:** Add medium ingredients from 7.9.1 to 900 mL water in a liter Erlenmeyer flask. Stir and heat to dissolve in a boiling water bath. Bring the pH to 7.6 with 1 N NaOH. Autoclave for

---

<sup>3</sup>**Peptone** (Difco 0118), Difco Laboratories, Detroit, MI, or equivalent.

15 min at 121°C (15 lbs pressure). Cool to 50°C. Add the following reagents aseptically and mix well:

D-cycloserine	0.4	g
Polymyxin B sulfate	0.025	g
4.5% FeCl <sub>3</sub> ·6H <sub>2</sub> O solution	2.0	mL
0.5% Phenolphthalein diphosphate solution	20.0	mL
0.075% Indoxyl-β-D-Glucoside solution	80.0	mL

7.9.3 Dispense 4-4.5 mL into each petri plate using a sterile Cornwall syringe or Brewer pipette. Store agar plates inverted in a plastic bag in a refrigerator for no more than one month. It is recommended that the plates be stored in an anaerobic chamber in the refrigerator for optimal preservation.

## 7.10 Modified Iron Milk Medium (7)

### 7.10.1 Composition/L

Fresh pasteurized, homogenized milk (3.5% butterfat)	1.0	L
FeSO <sub>4</sub> ·7H <sub>2</sub> O	1.0	g

7.10.2 **Preparation:** Dissolve ferrous sulfate in 50 mL water. Add slowly to 1 L milk and mix with magnetic stirrer. Dispense 11 mL of medium into culture tubes. Cap and autoclave 12 min at 118°C. CAUTION: Do not exceed the recommended time and temperature limits to avoid coagulation.

## 7.11 Fluid Thioglycollate Medium<sup>4</sup>

### 7.11.1 Composition/L

L-Cystine	0.5	g
Agar (granulated)	0.75	g
NaCl	2.5	g
Dextrose (anhydrous)	5.0	g
Yeast extract	5.0	g
Tryptone	15.0	g
Sodium thioglycollate	0.5	g
Resazurin	0.001	g

---

<sup>4</sup>Fluid Thioglycollate Medium (BBL 12461), Becton-Dickinson Microbiology Systems, Cockeysville, MD; (Difco 0432-02-6) Difco Laboratories, Detroit, MI; or equivalent.

7.11.2 **Preparation:** Suspend 29.25 g of medium in 1 L of water. Mix thoroughly and heat to boil for 1-2 min or until solution is complete. Final pH is  $7.1 \pm 0.1$ . Dispense 15 mL portions into culture tubes. Cap and autoclave for 15 min at 121 °C. Store tubes in the dark at room temperature. Do not refrigerate. If medium becomes oxidized (more than 30% of medium is pink), reheat once only in boiling water bath and cool before use.

## 7.12 Gram Stain Reagents

7.12.1 Gram stain reagent kits are commercially available and are recommended.

7.12.2 **Ammonium oxalate-crystal violet (Hucker's):** Dissolve 2 g crystal violet (90% dye content) in 20 mL 95% ethyl alcohol. Dissolve 0.8 g  $(\text{NH}_4)_2\text{C}_2\text{O}_4 \cdot \text{H}_2\text{O}$  in 80 mL water; mix the two solutions and age for 24 h before use. Filter through a 0.22  $\mu\text{m}$  membrane filter. Store in a glass bottle.

7.12.3 **Lugol's solution, Gram's modification:** Grind 1 g iodine crystals and 2 g KI in a mortar. Add water, a few mL at time, and grind thoroughly after each addition until solution is complete. Filter solution through a 0.22  $\mu\text{m}$  membrane filter, and rinse into an amber glass bottle with the remaining water (using a total of 300 mL).

7.12.4 **Counterstain:** Dissolve 2.5 g safranin dye in 100 mL 95% ethyl alcohol. Add 10 mL to 100 mL water. Filter through a 0.22  $\mu\text{m}$  membrane filter.

7.12.5 **Acetone alcohol:** Mix equal volumes of ethyl alcohol (95%) with acetone.

## 8. Sample Collection, Preservation and Holding Times

8.1 **Collection** - Water samples are collected in sterile sample containers with leak-proof lids.

8.2 **Sample Preservation and Holding Conditions** - Hold water samples at a temperature below 10°C during transit to the laboratory by placing them on ice, surrounding them with blue ice or by refrigeration. Use insulated containers to maintain storage temperature during transit. Take care that sample bottle closures are not submerged in water during transit or storage.

8.3 **Holding Time** - Refrigerate samples upon arrival in the laboratory and analyze within 8 h after collection. *C. perfringens* spores can survive for extended periods

at 1-4°C. However, since a correlation is planned with other indicators, the holding time for *C. perfringens* must be limited to that of the other indicators.

## **9. Quality Control**

- 9.1 Adherence to sampling procedures, preservation procedures and holding time limits is critical to the production of valid data. Reject samples if appropriate sampling, preservation and handling procedures have not been followed
- 9.2 Check and record temperatures in incubators daily to insure operation within stated limits.
- 9.3 Check thermometers at least annually against a National Institute of Standards and Technology (NIST) certified thermometer or one traceable to NIST and record the results. Examine mercury columns for separation and reunite before use. Adjust or post correction factors on equipment.
- 9.4 Use a loop to inoculate mCP agar plates with pure cultures of *C. perfringens* and *E. coli*. Carry these plates through the entire analytical procedure, as positive and negative controls.
- 9.5 For general quality control recommendations, see "Quality Assurance for Microbiological Analyses" in ASTM Special Technical Testing Publication 867 (8).

## **10. Procedure for Analyses of Water Samples for Spores**

- 10.1 Prepare mCP Agar according to Section 7.9.
- 10.2 Mark the bottoms of the petri plates and laboratory data sheets with sample identities and volumes.
- 10.3 Grasp a sterile membrane filter by its edge using a sterile forceps and place on the filter base, grid side up. Attach the funnel to the base of the filter unit; the membrane filter is now held between the funnel and the base.
- 10.4. **Procedure for Inactivation of Vegetative Cells** - To obtain a count only of *C. perfringens* spores, hold water samples in a waterbath at 60°C for 15 min to kill all vegetative cells.
  - 10.4.1 Equilibrate a waterbath at 60 C.
  - 10.4.2 Determine the time necessary to bring a blank sample to 60°C. Use the same size container and volume as used for water samples.



- 10.4.3 Immerse the containers containing the water samples in the waterbath for the time necessary to warm sample to 60°C plus 15 min. Do not allow the container cap or container opening to become contaminated by water in the bath.
- 10.4.4 Cool the sample containers in cold tap water immediately after heat shock and proceed with the analyses in 10.3.
- 10.5 For greatest accuracy, it is necessary to filter a sample volume that will yield a countable plate. Select sample volumes based on previous knowledge, which will produce membrane filter plates with 20-80 *C. perfringens* colonies. A narrow range of dilution factors of 4 or 5 can usually be used to achieve the desired number of colonies. An example of such factors is shown in **Table XI-1**. However, if past analyses of specific samples have resulted in confluent growth or "too numerous to count" (TNTC) membranes from excessive turbidity, additional samples should be collected and filtration volumes adjusted to provide isolated colonies from one or more smaller volumes. The counts from smaller volumes can be combined for a final count/total volume filtered.
- 10.6 Shake the sample bottle vigorously about 25 times and measure the desired volume of sample into the funnel with the vacuum off. To measure the sample accurately and obtain good distribution of colonies on the filter surface, use the following procedures:
- 10.6.1 Sample volumes of 20 mL or more: Measure the sample in a sterile graduated cylinder and pour it into the funnel. Rinse the graduate twice with sterile dilution water, and add the rinse water to the funnel.
- 10.6.2 Sample volumes of 10-20 mL: Measure the sample with a sterile 10 mL or 20 mL pipet into the funnel.
- 10.6.3 Sample volumes of 1-10 mL: Pour about 10 mL of sterile dilution water into the funnel without vacuum. Add the sample to the sterile water using appropriate sterile pipet and filter the sample.
- 10.6.4 Sample volumes of less than 1.0 mL: Prepare appropriate dilutions in sterile dilution water and proceed as applicable in steps 10.6.1-10.6.3 above.
- 10.6.5 To reduce the chance for carryover, when analyzing a series of samples or dilutions, filter samples in the order of increasing volumes of original sample. The time elapsing between preparation of sample dilutions and filtration should be minimal and never more than 30 min.

<b>Table XI-1. Sample Volumes to Obtain Colony Count on Membrane Filters *</b> <b>(Range of 20 - 80 Colonies)</b>	
<b>Sample Volume in mL</b>	<b>Added as:</b>
0.05	5.0 mL of 10 <sup>-2</sup> dilution
0.20	2.0 mL of 10 <sup>-1</sup> dilution
0.80	8.0 mL of 10 <sup>-1</sup> dilution
3.20	3.2 mL of Undiluted Sample
15.00	15.0 mL of Undiluted Sample
60.00	60.0 mL of Undiluted Sample

\*The range of volumes and dilutions selected for filtration of completely unknown samples can be broader, to provide a factor of 10 or more. Prepare at least three sample increments.

- 10.7 After adding the sample to filter funnel, turn on vacuum and filter the sample. Rinse the sides of the funnel walls at least twice with 20-30 mL of sterile dilution water. Turn off vacuum and remove the funnel from the filter base.
- 10.8 Flame forceps, cool and aseptically remove the membrane filter from the filter base. Place the filter, grid side up, on the mCP agar using a rolling motion to prevent air bubbles. Reseat the filter if bubbles occur.
- 10.9 Remove the lids from mCP agar plates. Invert lids and nest them under the corresponding plate bottom for identification. Stack the plates in layers in the anaerobic chamber, separating each plate with sterile filter paper. Incubate the anaerobic chamber at 44.5°C for 24 h, maintaining anaerobic conditions through the use of a commercial anaerobic system. If visible condensation does not occur within 60 min after the BBL GasPak is activated, the reaction should be terminated by opening the jar, and removing the GasPak. Inspect the chamber seal for alignment and lubricant. Insert a new GasPak and seal the chamber. The disposable anaerobic indicator (moistened flat fiber wick impregnated with 0.35% methylene blue solution) is white to pale blue upon opening foil envelope. It turns blue upon exposure to air. Under anaerobic conditions the methylene blue indicator will decolorize (turn white) within 2 - 4 h. It should remain white through the incubation period.
- 10.10 After 24 h, remove one agar plate at a time from the chamber and reclose the chamber. Examine the mCP plate for straw-yellow colonies. If such colonies are

present, invert and expose the open agar plate 10-30 sec to the fumes from an open container of concentrated ammonium hydroxide.

10.11 If *C. perfringens* colonies are present, the phosphate in the phenolphthalein diphosphate will be cleaved from the substrate by acid phosphatase and typical colonies of *C. perfringens* will turn a dark pink or magenta after exposure to fumes of ammonium hydroxide.

10.12 Count pink or magenta colonies as presumptive *C. perfringens*.

10.13 Repeat steps 10.10 to 10.12 with the other culture plates.

## **11. Confirmation Tests**

11.1 Pick at least 10 typical isolated *C. perfringens* colonies from the mCP plate and transfer each into a separate thioglycollate tube. Incubate at 35°C for 24 h. Examine by gram stain and for purity. *C. perfringens* are short gram-positive bacilli. Retain tubes for further testing.

11.2 Inoculate ten tubes of iron milk medium with 1 mL from the ten fluid thioglycollate tubes and incubate in a 44.5°C waterbath for two h. Examine hourly for stormy fermentation with rapid coagulation and fractured rising curd.

11.3 Those colonies which are gram-positive, non-motile, and produce stormy fermentation of milk in these confirmatory tests are considered confirmed *C. perfringens*.

## **12. Data Analyses, Calculations and Reporting Results**

12.1 Pink or magenta colonies counted on mCP medium are adjusted to a count/100 mL and reported as: Presumptive *C. perfringens* colony forming units (CFU)/100 mL. The presumptive count is normally used for routine monitoring.

12.2 If confirmation tests are performed, original counts on mCP agar are adjusted based on the percent of colonies picked and confirmed. Report as confirmed *C. perfringens* CFU/100 mL of water sample.

## **13. Method Performance Characteristics**

13.1 The detection limit is one *C. perfringens* CFU per sample volume or sample dilution tested.

- 13.2 The false positive rate is reported to be 7-9% by Bisson and Cabelli (2) and Fujioka and Shizumura (10). The false negative rate is reported to be 3% by Fujioka and Shizumura (10).
- 13.3 The single laboratory recovery is reported to be 79-90% by Bisson and Cabelli (2).
- 13.4 In a collaborative study, sixteen analysts from nine laboratories analyzed a sediment, a non-chlorinated wastewater and three spiked waters (marine water, lake water and a finished drinking water), as unknowns. Analysts were provided range values to reduce the number of dilutions necessary for the analyses.
- 13.4.1 The single operator precision as % Relative Standard Deviation (RSD) ranged from 14-28% while the overall precision (as % RSD) ranged from 24-41%, for  $S_t/S_o$  (overall precision/single operation precision) ratios of 1.13-1.80. The larger RSD values were not generated with the more difficult sample matrices of sediment and wastewater. Rather, they occurred with the seeded finished drinking water sample and are believed to have been caused by overestimates of the concentration of *C. perfringens*, which resulted in marginally low plate counts with inherently greater deviations. Overall, the  $S_t$  and  $S_o$  values were similar across sample types and concentration levels of *C. perfringens*.
- 13.4.2 Although there were no "standards" available for this RR study, sample 5, a seeded drinking water, had a reference count of 78 *C. perfringens* CFU/100 mL. The laboratories in this study achieved a mean recovery of 67 CFU from Sample 5 for an 86 percent recovery.
- 13.4.3 **Table XI-2** contains the statistical summary of the collaborative study results.

<b>Table XI-2. Statistical Evaluation of Results (CFU/100 mL) (After Rejection of Outliers)</b>							
Sample	Initial n	Final n	X	$S_o$	$S_t$	%RSD ( $S_o$ )	%RSD ( $S_t$ )
1	30	30	2893.63	397.78	715.45	13.75	24.73
2	36	35	108.09	20.34	26.18	18.82	24.22
3	30	30	73.07	20.29	23.23	27.77	31.79
4	36	35	5985.71	1400.70	1585.80	23.40	26.49
5	27	27	67.22	18.64	27.60	27.73	41.06

## 14. Pollution Prevention

- 14.1 Pollution prevention is any technique that reduces or eliminates the quantity or toxicity of waste at the point of generation. It is the environmental management tool preferred over waste disposal or recycling. When feasible, laboratory staff should use a pollution prevention technique such as preparation of the smallest practical volumes of reagents, standards and media or downsizing of the test units in a method.
- 14.2 The laboratory staff should also review the procurement and use of equipment and supplies for other ways to reduce waste and prevent pollution. Recycling should be considered whenever practical.

15. **Waste Management** - The Environmental Protection Agency requires that laboratory waste management practices be conducted consistent with all applicable rules and regulations. The Agency urges laboratories to protect the air, water and land by minimizing and controlling releases from hoods and bench operations, complying with the letter and spirit of sewer discharge permits and regulations and by complying with solid and hazardous waste regulations, particularly the hazardous waste identification rules and land disposal restrictions.

16. **Key Words** - *Clostridium*, *Clostridium perfringens*, anaerobic bacteria, spore-forming bacteria, indicator organisms, pollution, water quality.

## 17. References:

1. Armon, R. and P. Payment, 1988. A modified mCP Medium for enumerating *Clostridium perfringens* from Water Samples. *Can. J. Microbiol.* **34**: 78-79.
2. Bisson, J.W., and V.J. Cabelli, 1979. membrane filter enumeration method for *Clostridium perfringens*, *Appl. Environ. Microbiol.* **37**:55-66.
3. St. John, W.D., J.R. Matches, and M.M. Wekell, 1982. Use of iron milk medium for enumeration of *Clostridium perfringens*. *J. Assoc. Off. Anal. Chem.* **65**:1129-1133.
4. Brenner, K. and C. Rankin, 1990. New Screening Test to Determine the Acceptability of 0.45  $\mu\text{m}$  Membrane Filters of Analysis of Water, *Appl. Environ. Microbiol.*, **56**:54-64.
5. Reagent Chemicals, American Chemical Society Specifications, American Chemical Society, Washington, DC. For suggestions on testing reagents not listed by the American Chemical Society, see Analar Standards for Laboratory Chemicals, BDH LTD, Poole, Dorset, U.K. and the United States Pharmacopeia.

6. American Society for Testing and Materials, Annual Book of ASTM Standards, Vol. 11.01. ASTM, Philadelphia, PA 19103-1187.
7. FDA Bacteriological Analytical Manual, 7th Ed., AOAC International, Arlington, VA, 1992, Iron Milk Medium (modified), 476-477.
8. Bordner, R.H., J.A. Winter and P.V. Scarpino (eds.), 1978. Microbiological Methods for Monitoring the Environment, Water and Wastes, EPA-600/8-78-017, U.S. Environmental Monitoring and Support Laboratory, Cincinnati, Ohio, 5-31 or Bordner, R., 1985. Quality Assurance for Microbiological Analyses of Water. in: **Quality Assurance for Environmental Measurements** . ASTM STP 867, American Society for Testing and Materials, Philadelphia, PA, pp. 133-143.5
9. Standard Methods for the Examination of Water and Wastewater, 18th ed. 1992. APHA, Washington, D.C., 1992, Sections 9060A and 9060B.
10. Fujioka, R.S. and Shizumura, L.K. 1985. *Clostridium perfringens*, A Reliable Indicator of Stream Water Quality, JWPCF, **57**:986-992.

## APPENDIX A. VERIFICATION OF STATE CERTIFICATION

Please complete the following:

**Laboratory Name:** \_\_\_\_\_

**Address:** \_\_\_\_\_

**City:** \_\_\_\_\_ **State:** \_\_\_\_\_ **Zip:** \_\_\_\_\_

**Contact Person:** \_\_\_\_\_

**Telephone:** (    ) \_\_\_\_\_

**Laboratory Type:**    **Utility:** \_\_\_\_\_ **Commercial:** \_\_\_\_\_ **State:** \_\_\_\_\_ **Other:** \_\_\_\_\_

**Certification:** The information requested in this section is necessary to verify the Drinking Water Laboratory certifications listed below. Please fill-out completely and supply all requested documentation.

ANALYTICAL METHODS PERFORMED	(Indicate Methods Performed with a ✓)	STATE(S) in Which Certified	CERTIFICATION	
			Type	Certification Date
TC-MF				
TC-MTF				
FC-MF				
FC-MTF				
EC + MUG				
ONPG - MUG				
NA + MUG				

Please attach a copy of your current letter(s) or certificate(s) of approval for conducting the above analyses and return to:

ICR Laboratory Coordinator  
 U.S. EPA, OGWDW  
 Technical Support Division  
 26 West Martin Luther King Drive  
 Cincinnati, Ohio 45268

## **APPENDIX B. APPLICATION FOR LABORATORY APPROVAL FOR THE INFORMATION COLLECTION RULE (ICR)**

The U.S. Environmental Protection Agency (EPA) is proposing to require public water systems which serve 10,000 people or greater to generate and provide the Agency with specific monitoring data and other information characterizing their systems. Depending on the population served, systems which use surface water, or ground water under the direct influence of surface water, would be required to monitor their source water at the intake of each plant for two disease-causing protozoa, *Giardia* and *Cryptosporidium*, total coliforms and fecal coliforms or *Escherichia coli*. Systems which serve more than 100,000 people would be required to monitor their source water at the intake of each plant for the microorganisms indicated above, plus total culturable viruses. When pathogen levels equal or exceed one virus or protozoan per liter in the source water, systems would also be required to monitor their finished waters for these microorganisms.

Laboratories monitoring for protozoa and viruses would have to be approved by the U.S. EPA. The attached information describes the minimal requirements for approval to perform protozoan and/or virus analyses under the Information Collection Rule. Accepted applicants will also be required to demonstrate capabilities based on analyses of unknown samples and an on-site inspection of their facility.

Those interested in being approved must first demonstrate their qualifications by completing the attached application(s) and forwarding it (them) to:

ICR Laboratory Coordinator  
U.S. Environmental Protection Agency  
Office of Ground Water and Drinking Water  
Technical Support Division  
26 West Martin Luther King Drive  
Cincinnati, Ohio 45268

Qualified applicants will be provided a copy of the **ICR Microbial Laboratory Manual** describing fully the approval requirements.

Since total coliform and fecal coliform/*E. coli* analyses proposed under the ICR are required under the Drinking Water Laboratory Certification Program, laboratory approval for these analyses is not required under the ICR if State certification can be verified (see **Appendix A**).



## MINIMAL REQUIREMENTS FOR VIRUS LABORATORIES

### **Background Information:**

For ICR approval, the virus analytical laboratories must have suitable facilities, equipment, instrumentation, and an ongoing quality assurance (QA) program. Analysts must be experienced in viral analyses and meet performance evaluation criteria. As laboratories are approved, the U.S. EPA will provide an updated list of those laboratories with Agency approved analysts to the public water systems that serve a population of 100,000 or more.

### **Analytical Methods:**

The proposed virus protocol was published in the **Federal Register**, Vol. 59, No. 28, February 10, 1994, 40 CFR Part 141 **Monitoring Requirements For Public Drinking Water Supplies**; Proposed Rule; pp. 6430-6444. The final draft method will be provided to those applicants that meet the minimal requirements set forth in this document. The final method will be available at the time the ICR is promulgated.

### **Sample Collection:**

Each analytical laboratory will be responsible for procuring, assembling, sterilizing, and transporting the sample collection apparatus to the water system. Systems will be advised on proper collection techniques by the analytical laboratory in accordance with the procedures in the ICR virus protocol. A virus sampling video will be available to the system to reinforce instructions received from the analytical laboratory.

### **Approval of an Analytical Laboratory:**

The minimal requirements for personnel (education; training or equivalent experience), facilities, equipment and instrumentation, QA/quality control (QC), etc. listed below must be met and documented in the application before the laboratory and analysts will be judged qualified to be considered for approval. If the above criteria are met, ICR approval to perform analyses will require: 1) successful performance on QC samples, as defined in the virus protocol, 2) satisfactory analyses on unknown performance evaluation (PE) samples, and 3) an on-site evaluation of the laboratory and the analyst(s).

### **QC Samples/Cell Line:**

EPA will provide QC samples containing known virus concentrations to laboratories meeting minimal requirements. These samples are to be used initially and periodically thereafter to demonstrate the analyst(s)' ability to process and analyze samples correctly. Buffalo green monkey (BGM) cells will be provided to establish uniform cell cultures in all laboratories.

## **Minimal Requirements:**

### **1. Personnel:**

**Principal Analyst/Supervisor:** To be qualified for approval, a laboratory must have a principal analyst who may also serve as a supervisor if an additional analyst(s) is to be involved. The principal analyst/supervisor oversees or performs the entire analyses and carries out QC performance checks on technicians and/or other analyst(s). This person must be an experienced microbiologist with at least a B.A./B.S. degree in microbiology or a closely related field and a minimum of three years continuous bench experience in cell culture propagation, processing of virus samples, and animal virus analyses. This analyst must have analyzed a PE sample set using the ICR virus method and results must fall within acceptance limits. Also, the principal analyst must demonstrate acceptable performance during an on-site evaluation by U.S. EPA personnel.

**Analyst:** This person(s) performs at the bench level under the supervision of a principal analyst and can be involved in all aspects of analysis, including preparation of sampling equipment, filter extraction, sample processing, cell culture, virus assay, and data handling. The analyst must have two years of college lecture and laboratory course work in microbiology or a closely related field. The analyst must have at least six months bench experience in cell culture and animal virus analyses, including three months experience in filter extraction of virus samples and sample processing. Six months of additional bench experience in the above areas may be substituted for the two years of college. Each analyst must have analyzed a PE sample set using the ICR virus method and results must fall within acceptance limits. The analyst must also demonstrate acceptable performance during an on-site evaluation.

**Technician:** This person extracts filters and processes the samples under the supervision of an analyst, but does not perform cell culture work, virus detection or enumeration. The technician must have at least three months experience in filter extraction and processing of virus samples.

**2. Laboratory Facilities:** Laboratories must have an air system regulated for temperature, humidity and air cleanliness. Laboratories should be maintained under negative air pressure to protect against accidental release of viral pathogens and should be equipped with ultraviolet lights for decontamination of rooms during periods when personnel are absent. Laboratories should maintain separate rooms for preparing cell cultures and processing virus samples. However, in the absence of separate rooms, laminar flow hoods must be used for cell culture preparation to prevent contamination. Freezers, incubators, and other large instruments should be in rooms where they can be accessed without disturbing ongoing laboratory efforts. The area provided for preparation and sterilization of media, glassware, and equipment should be separate from other laboratory work areas, but close enough for convenience. Visitors and through traffic must be minimized in work areas. ICR samples will be archived for future

testing by polymerase chain reaction (PCR) methods which are sensitive to contamination. Therefore, rooms for processing and assaying ICR samples must not have been used for analyzing PCR products. For ICR studies, the minimal area recommended for each worker is six to ten linear feet of usable bench space per analyst, exclusive of areas requiring specialized equipment or used for preparatory and supportive activities. Bench tops should be stainless steel, epoxy plastic, or other smooth impervious material that is inert and corrosion-resistant. Laboratory lighting should be even, screened to reduce glare, and provide about 100 foot-candles of light intensity on working surfaces.

High standards of cleanliness must be maintained in work areas. Laboratory bench surface cleanliness and laboratory air quality must be monitored. The laboratory must have a pest control program that includes preventive measures such as general cleanliness and prompt disposal of waste materials. The laboratory must be in compliance with all applicable judicial ordinances and laws for the managing and disposal of pathogenic agents.

3. **Laboratory Equipment And Instrumentation:** The laboratory must be equipped on-site with the instrumentation and equipment needed to perform the virus sample collection, extraction, concentration and assay as set forth in the ICR virus protocol. Included are incubators, water baths, hot air sterilizing ovens, autoclaves, refrigerators with -20°C freezer compartment, -70°C deep freezers, reagent grade water supply, balances, pH meter, centrifuges, temperature recording devices, and both upright and inverted microscopes. Laminar flow hoods and UV lights are strongly recommended as added equipment within the analytical laboratory.

4. **Safety:** Laboratory must meet Biosafety Level 2 Criteria as described in **Biosafety in Microbiological and Biomedical Laboratories**, 3rd Ed., HHS Publication No. (CDC) 93-8395. U.S. Government Printing Office, May, 1993. **Immunocompromised individuals must not work in or be admitted to this area.**

5. **QA/QC Procedures:** A formal QA document must be prepared and should follow the guidelines for a laboratory QA Plan, p. 7 in the **Manual for the Certification of Laboratories Analyzing Drinking Water**, 1990, U. S. Environmental Protection Agency Publication No. EPA/570/9-90/008, 3rd Ed., Washington, D.C., and Section II of this Manual. Laboratories must have a written QA program that applies practices necessary to minimize errors in laboratory operations that are attributable to personnel, equipment, supplies, processing procedures, or analytical methods. These include records of routine monitoring of equipment and instrumentation performance. Records of QC checks must be available to the U.S. EPA for inspection. The procedures for preparation of reagents and cell cultures and performance of the method must be followed exactly as written in the U.S. EPA ICR virus method. Reagents must be stored no longer than the designated shelf life.

6. **Record-Keeping And Data Reporting:** A record system must be in use for tracking the samples from sample collection through log-in, analyses and data reporting.

**INFORMATION COLLECTION RULE**

**APPLICATION FOR APPROVAL OF VIRUS LABORATORIES AND ANALYSTS <sup>1</sup>**

**Laboratory:** \_\_\_\_\_

**Address:** \_\_\_\_\_

**City:** \_\_\_\_\_ **State:** \_\_\_\_\_ **Zip:** \_\_\_\_\_

**Contact Person:** \_\_\_\_\_

**Title:** \_\_\_\_\_

**Telephone:** ( ) \_\_\_\_\_ **Fax:** ( ) \_\_\_\_\_

**Type of Laboratory:** Commercial \_\_\_\_\_ Utility \_\_\_\_\_ State \_\_\_\_\_ Academic \_\_\_\_\_

**Other (describe)** \_\_\_\_\_

**Principal Customers:** Environmental \_\_\_\_\_ Clinical \_\_\_\_\_ Other \_\_\_\_\_

**Type of Virus analyses:** Human \_\_\_\_\_ Animal \_\_\_\_\_ Bacterial \_\_\_\_\_

**Other (describe)** \_\_\_\_\_

**PERSONNEL QUALIFICATIONS**

**Name, education, virus analysis experience and field in which acquired (water, waste-water, soils/sludge, shellfish, clinical, etc.)**

**Principal Analyst/Supervisor:** \_\_\_\_\_

**Education [University/Degree(s)]:** \_\_\_\_\_

**Experience:** \_\_\_\_\_

\_\_\_\_\_  
\_\_\_\_\_  
\_\_\_\_\_

<sup>1</sup>Where additional pages are required, clearly mark them using the same headings as in this application form.

**Analyst #1:** \_\_\_\_\_

**Education:** \_\_\_\_\_

**Experience:** \_\_\_\_\_

**Analyst #2:** \_\_\_\_\_

**Education:** \_\_\_\_\_

**Experience:** \_\_\_\_\_

**Analyst #3:** \_\_\_\_\_

**Education:** \_\_\_\_\_

**Experience:** \_\_\_\_\_

**Technician #1:** \_\_\_\_\_

**Education:** \_\_\_\_\_

**Experience:** \_\_\_\_\_

**Technician #2:** \_\_\_\_\_

**Education:** \_\_\_\_\_

**Experience:** \_\_\_\_\_

**Technician #3:** \_\_\_\_\_

**Education:** \_\_\_\_\_

**Experience:** \_\_\_\_\_

ON-SITE LABORATORY EQUIPMENT AND INSTRUMENTATION

ITEM	On <sup>a</sup> Order	Number	TYPE/MODEL
Reagent Water System			
Sterilizing Oven			
Incubator			
Centrifuge			
pH Meter			
Temperature Recorder			
Inverted Microscope			
Upright Microscope			
Autoclave			
-70°C Freezer			
Refrigerator			
Analytical Balance			
UV Light System			
Water Bath			
Other(s) (describe)			
<sup>a</sup> Place a "✓" in the "On Order" column next to items that are on order.			

CURRENT LABORATORY PROGRAMS

Virus Method(s) (processing, assay)	Number of Analyses Per Year Per Meth- od and Virus Groups Analyzed



## MINIMAL REQUIREMENTS FOR PROTOZOAN LABORATORIES

### **Background Information:**

For ICR approval, the protozoan analytical laboratories must have suitable facilities, equipment, instrumentation, and an ongoing quality assurance (QA) program. Analysts must be experienced in protozoan analyses and meet performance evaluation criteria. As laboratories are approved, the U.S. EPA will provide an updated list of those laboratories with Agency approved analysts to the public water systems that serve a population of 10,000 or more.

### **Analytical Methods:**

The proposed protozoan method was published in the **Federal Register**, Vol. 59, No. 28, February 10, 1994, 40 CFR Part 141 **Monitoring Requirements For Public Drinking Water Supplies**; Proposed Rule; pp. 6416-6429. The final draft method will be provided to those applicants that meet the minimum requirements set forth in this document. The final method will be available at the time the ICR is promulgated.

### **Sample Collection:**

Analytical laboratories will be responsible for procuring, assembling, and transporting the sample collection apparatus to the water system. Systems will be advised on proper collection techniques by the analytical laboratory in accordance with the procedures described in the protozoan protocol. A sampling video will be available to the systems to reinforce instructions received from the analytical laboratory.

### **Approval of the Analytical Laboratory:**

The minimal requirements for personnel (education; training or equivalent experience), facilities, instruments, QA/QC, etc. listed below must be met and documented in this application before laboratories and analyst(s) will be judged qualified to be considered for approval. If the above criteria are met, ICR approval to perform analyses also will require: 1) recovery of both *Giardia* cysts and *Cryptosporidium* oocysts from QC samples, 2) satisfactory analyses on unknown PE samples and 3) an on-site evaluation of the laboratory and the analyst(s).

### **QC Samples:**

The U.S. EPA will provide QC samples containing known *Giardia* and *Cryptosporidium* concentrations to laboratories meeting minimal requirements. These samples are to be used initially and periodically thereafter to demonstrate the analyst(s)' ability to process and analyze samples correctly.



## Minimal Requirements:

### 1. Personnel:

**Principal Analyst/Supervisor**: To be qualified for approval, a laboratory must have a principal analyst who may also serve as a supervisor if an additional analyst(s) is to be involved. The principal analyst/supervisor oversees or performs the entire analyses and carries out QC performance checks on technicians and/or other analysts. The principal analyst/supervisor must confirm all protozoan internal structures demonstrated at the microscope by subordinates. This person must be an experienced microbiologist with at least a B.A./B.S. degree in microbiology or a closely related field. The principal analyst also must have at least one year of continuous bench experience with immunofluorescent antibody (IFA) techniques and microscopic identification and have analyzed at least 100 water and/or wastewater samples for *Giardia* and/or *Cryptosporidium*. In addition, PE samples must be analyzed using the ICR protozoan method and results must fall within acceptance limits. The principal analyst/supervisor must also demonstrate acceptable performance during an on-site evaluation.

**Analyst**: This person(s) performs at the bench level under the supervision of a principal analyst/supervisor and is involved in all aspects of the analysis, including preparation of sampling equipment, filter extraction, sample processing, microscopic protozoan identification, and data handling. Recording presence or absence of morphological characteristics may be done by the analyst but must be confirmed by the principal analyst. The analyst must have two years of college lecture and laboratory course work in microbiology or a closely related field. The analyst also must have at least six months bench experience, must have at least three months experience with IFA techniques, and must have analyzed at least 50 water and/or wastewater samples for *Giardia* and/or *Cryptosporidium*. Six months of additional bench experience in the above areas may be substituted for two years of college. In addition, PE samples must be analyzed using the ICR protozoan method and results must fall within acceptance limits. The analyst must also demonstrate acceptable performance during an on-site evaluation.

**Technician**: This person extracts filters and processes the samples under the supervision of an analyst, but does not perform microscopic protozoan detection and identification. The technician must have at least three months experience in filter extraction and processing of protozoa samples.

**Laboratory Facilities**: The laboratory must have dedicated, well-lighted bench space commensurate with the number of samples to be analyzed. Six to ten feet of usable bench space are required per analyst, exclusive of areas requiring specialized equipment or used for preparatory and supportive activities. Bench tops should be stainless steel, epoxy plastic or other smooth impervious material that is corrosion-resistant. Laboratory lighting should be even, screened to reduce glare, and provide 100 foot-candles of light intensity on working

surfaces. Laboratory floor space must be sufficient for stationary equipment such as refrigerators and low-speed and large-capacity centrifuges. Facilities for washing and sterilization of laboratory glassware, plasticware and equipment must be present. A dedicated space that can be darkened must be available for the microscopic work. Laboratory areas should be kept free of clutter and equipment and supplies should be stored when not in use. It is strongly recommended that laboratories should be maintained under negative air pressure to protect against accidental release of pathogens and should be equipped with ultraviolet lights for decontamination of rooms during periods when personnel are absent. High standards of cleanliness must be maintained in work areas. The laboratory must have a pest control program that includes preventive measures such as general cleanliness and prompt disposal of waste materials. The laboratory must be in compliance with all applicable judicial ordinances and laws for management and disposal of pathogenic agents.

3. **Laboratory Equipment And Instrumentation:** The laboratory must be equipped on-site with a reagent water supply system, autoclave, refrigerator (4°C) with -20°C freezer compartment, pH meter, slide-warming tray or incubator (37 ± 3°C), balance (top loader or pan), membrane filtration equipment for epifluorescent staining, and hydrometer set. Specific requirements for the microscope include differential interference contrast (DIC) or Hoffman modulation optics (including 20X and 100X objectives). DIC or Hoffman modulation optics should have epifluorescence capability. The epifluorescence vertical illuminator should have either a 50 or 100 watt high-pressure mercury bulb with appropriate excitation and band-pass filters (exciter filter: 450-490 nm; dichroic beam-splitting mirror: 510 nm; barrier or suppression filter: 515-520 nm) for examining fluorescein isothiocyanate-labeled specimens.

4. **Safety:** The laboratory must meet Biosafety Level 2 Criteria as described in **Biosafety in Microbiological and Biomedical Laboratories**, 3rd Ed., HHS Publication No. (CDC) 93-8395. U.S. Government Printing Office, May, 1993. **Immunocompromised individuals must not work in or be admitted to this area.**

5. **QA/QC Procedures:** A formal QA document must be prepared and should follow the guidelines for a laboratory QA Plan, p. 7 in the **Manual for the Certification of Laboratories Analyzing Drinking Water**, 1990, U. S. Environmental Protection Agency Publication No. EPA/570/9-90/008, 3rd Ed., Washington, D.C., and Section II of this Manual. Laboratories must have a written QA program that applies QC practices necessary to minimize errors in laboratory operations that are attributable to personnel, equipment, supplies, processing procedures, or analytical methods. These include records of routine monitoring of equipment and instrumentation performance. Records of all QC checks must be available to the U.S. EPA for inspection. The procedures for the preparation of reagents and performance of the method must be followed exactly as written in the U.S. EPA ICR protozoan method. Reagents must be stored no longer than the designated shelf life.

6. **Record-Keeping And Data Reporting:** A record system must be in use for tracking the samples from sample collection through log-in, analyses and data reporting.

**INFORMATION COLLECTION RULE**

**APPLICATION FOR APPROVAL OF PROTOZOAN LABS AND ANALYSTS**<sup>2</sup>

**Laboratory:** \_\_\_\_\_

**Address:** \_\_\_\_\_

**City:** \_\_\_\_\_ **State:** \_\_\_\_\_ **Zip:** \_\_\_\_\_

**Contact Person:** \_\_\_\_\_

**Title:** \_\_\_\_\_

**Telephone:** ( ) \_\_\_\_\_ **Fax:** ( ) \_\_\_\_\_

**Type of Laboratory:** Commercial \_\_\_\_\_ Utility \_\_\_\_\_ State \_\_\_\_\_ Academic \_\_\_\_\_  
Other (describe) \_\_\_\_\_

**Principal Customers:** Environmental \_\_\_\_\_ Clinical \_\_\_\_\_ Other \_\_\_\_\_

**Type of Protozoa** *Giardia* \_\_\_\_\_ *Cryptosporidium* \_\_\_\_\_ *Entamoeba* \_\_\_\_\_

**Analyses:** Other (describe) \_\_\_\_\_

**PERSONNEL QUALIFICATIONS**

**Name, education, protozoan analysis experience and field in which acquired (water, wastewater, clinical, etc.)**

**Principal Analyst/Supervisor:** \_\_\_\_\_

**Education [University/Degree(s)]:** \_\_\_\_\_

**Experience:** \_\_\_\_\_

\_\_\_\_\_  
\_\_\_\_\_  
\_\_\_\_\_

\_\_\_\_\_

<sup>2</sup>Where additional pages are required, clearly mark them using the same headings as in this application form.

**Analyst #1:** \_\_\_\_\_

**Education:** \_\_\_\_\_

**Experience:** \_\_\_\_\_

**Analyst #2:** \_\_\_\_\_

**Education:** \_\_\_\_\_

**Experience:** \_\_\_\_\_

**Analyst #3:** \_\_\_\_\_

**Education:** \_\_\_\_\_

**Experience:** \_\_\_\_\_

**Technician #1:** \_\_\_\_\_

**Education:** \_\_\_\_\_

**Experience:** \_\_\_\_\_

**Technician #2:** \_\_\_\_\_

**Education:** \_\_\_\_\_

**Experience:** \_\_\_\_\_

**Technician #3:** \_\_\_\_\_

**Education:** \_\_\_\_\_

**Experience:** \_\_\_\_\_

ON-SITE LABORATORY EQUIPMENT AND INSTRUMENTATION

ITEM	On Order	Number	TYPE/MODEL
Autoclave			
Refrigerator			
Freezer			
pH Meter			
Analytical Balance			
Top-loader Balance			
Membrane Filtration Equipment (for epifluorescent staining)			
Hydrometer Set			
Reagent Grade Water Supply			
Slide Warmer			
Incubator			
Centrifuge			
Centrifuge Rotors			
Other(s) (describe)			
Place a "✓" in the "On Order" column next to items that are on order.			

MICROSCOPE CAPABILITY

Vendor Name: \_\_\_\_\_ Model: \_\_\_\_\_

**Optical Capability:**

Epifluorescence      Yes \_\_\_\_\_      No \_\_\_\_\_

DIC      Yes \_\_\_\_\_      No \_\_\_\_\_

Hoffman Modulation      Yes \_\_\_\_\_      No \_\_\_\_\_

Mercury Lamp      \_\_\_\_\_ watt bulb

FITC Cube Specs.      \_\_\_\_\_ nm exciter filter;  
 \_\_\_\_\_ nm beam splitting dichroic mirror; or  
 \_\_\_\_\_ nm barrier or suppression filter

Objective Power	Type (Achromate, Neofluor, oil, etc.)	Numerical Aperture	Used with (Epifluor, D.I.C., etc.)

CURRENT LABORATORY PROGRAMS

Protozoan Method(s)	Number of Analyses Per Year Per Method



**APPENDIX C. CHECKLIST FOR LABORATORY APPROVAL FOR  
*GIARDIA AND CRYPTOSPORIDIUM***



<b>ICR Protozoan Laboratory Checklist</b>			
<b>Laboratory:</b>			
<b>Address:</b>			
<b>City:</b>		<b>State:</b>	<b>Zip:</b>
<b>Type of Laboratory (Check):</b>			
<b>Commercial:</b>	<b>Utility:</b>	<b>State:</b>	<b>Academic:</b>
<b>Other (Describe):</b>			
<b>Principal Customers: (Check)</b>	<b>Environmental: Other (Describe):</b>	<b>Clinical:</b>	
<b>Type of Protozoan Analyses: (Check each)</b>	<i>Giardia:</i>	<i>Cryptosporidium:</i>	<i>Entamoeba:</i>
	<b>Other (describe):</b>		
<b>Laboratory Contact Person:</b>			
<b>Title:</b>			
<b>Telephone:</b>		<b>Fax:</b>	
<b>Principal Analyst/Supervisor Name:</b>			
<b>Analyst Name:</b>			
<b>Name of Person Being Evaluated:</b>			
<b>Laboratory Evaluated by:</b>			<b>Date:</b>

ICR Protozoan Laboratory Checklist		
Question	Answer	
	Yes	No
Are the personnel listed on the ICR approval application still with the laboratory?		
Are there any personnel in the laboratory not listed on the ICR approval application?		
Is the documentation available showing that the principal analyst/supervisor has analyzed 100 water and/or wastewater samples for <i>Giardia</i> and/or <i>Cryptosporidium</i> ?		
Is the documentation available showing that the analyst has analyzed 50 water and/or wastewater samples for <i>Giardia</i> and/or <i>Cryptosporidium</i> ?		
Is the laboratory well lighted (approximately 100 foot-candles of light intensity on work surfaces)?		
Are 6-10 ft of bench space available per analyst?		
Are the bench tops made of a smooth, impervious surface?		
Is the laboratory floor space sufficient for the stationary equipment?		
Is glassware washing equipment available?		
Is the laboratory neatly organized with unused equipment and supplies being stored (free of clutter)?		
Are high standards of cleanliness and prompt disposal of waste materials exhibited?		
Is the laboratory equipped with ultraviolet lights and under negative air pressure?		
Does the laboratory have a reagent grade water system?		
Does the laboratory have an autoclave?		
Does the laboratory have a refrigerator (4°C) with a -20°C freezer compartment?		
Does the laboratory have a pH meter associated with two or three calibration buffers?		
Does the laboratory have either an incubator or slide warming table calibrated to 37 ± 3°C?		

## ICR Protozoan Laboratory Checklist

Question	Answer	
	Yes	No
Does the laboratory have either a top loader or pan balance associated with calibration weights?		
Does the laboratory have a properly maintained and adjusted stomacher?		
Does the laboratory have a Hoefer filtration manifold, model FH 255V?		
Are the well weights for the Hoefer manifold well maintained?		
Are the microscope slides the appropriate size?		
Is the laboratory using clear nail polish to seal the coverslips to the slides?		
Are the cover slips 25 mm <sup>2</sup> and No. 1½?		
Does the laboratory have a hydrometer set covering the range 1.0-2.0?		
Does the laboratory have an epifluorescent microscope equipped with either Hoffman modulation or differential interference contrast optics?		
Is the microscope easily changed from epifluorescent optics to either Hoffman modulation or differential interference contrast optics and vice versa?		
Does the laboratory have a 20X scanning objective with a numerical aperture of 0.6 on the microscope?		
Is the microscope equipped with an ocular micrometer or some other measuring device?		
Has the ocular micrometer been calibrated in conjunction with the 20X and the 100X objectives?		
Is a table of objective calibrations near the microscope?		
Does the laboratory have a stage micrometer?		
Does the laboratory have a 100X objective with a numerical aperture of 1.3 on the microscope?		

<b>ICR Protozoan Laboratory Checklist</b>		
<b>Question</b>	<b>Answer</b>	
	<b>Yes</b>	<b>No</b>
Is the epifluorescent portion of the microscope equipped with an appropriate excitation and band pass filters for examining fluorescein isothiocyanate-labeled specimens (exciter filter: 450-490 nm; dichroic beamsplitting mirror 510 nm; barrier or suppression filter: 515-520 nm)?		
Is the mercury bulb in the epifluorescent lamp house either a 50 or a 100 watt bulb?		
Does the laboratory keep a log or have an hour totalizer on the transformer of the number of hours on the mercury bulb?		
Has the mercury bulb been used longer than 100 h in the case of 50 watt bulb or longer than 200 h in the case of a 100 watt bulb?		
Can the principal analyst/supervisor establish Köhler illumination on the microscope?		
Can the analyst establish Köhler illumination on the microscope?		
Can the principal analyst/supervisor focus both microscope eyepieces?		
Can the analyst focus both microscope eyepieces?		
Did the principal analyst/supervisor adjust the interpupillary distance?		
Did the analyst adjust the interpupillary distance?		
Does the laboratory have a large capacity centrifuge?		
Does the laboratory have a swinging bucket rotor capable of spinning 250 ml capacity or greater screw-cap conical bottles?		
Does the laboratory have a swinging bucket rotor capable of spinning 50 ml capacity conical screw-cap tubes?		
Does the laboratory have a formal QA laboratory plan prepared and ready for examination?		
Does the laboratory have records of all QC checks available for inspection?		
Does the laboratory have an adequate record system for tracking samples from collection through log-in, analysis and data reporting?		

<b>ICR Protozoan Laboratory Checklist</b>		
<b>Question</b>	<b>Answer</b>	
	<b>Yes</b>	<b>No</b>
Is a positive and a negative <b>Quality Control</b> filter run with each week's batch of filters being analyzed?		
Is the laboratory using Commercial filters with Commercial LT-10 filter holders or Filterite filters with Filterite filter holders?		
Are the sampling filters 10 in (25.4 cm) long and 1 $\mu$ m in nominal porosity?		
Is the sampling apparatus configured appropriately for raw water sampling?		
Is the sampling apparatus configured appropriately for finished water sampling?		
Is the sampling apparatus cleaned well before reshipment and/or use?		
Does the laboratory have a checklist or set of sampling instructions which are used, when sampling is done by someone other than laboratory personnel?		
Are reagents well labelled with preparation dates and who prepared the reagent?		
Does the laboratory have formulation or recipe cards for the preparation of 2.0% sodium thiosulfate, 10% neutral buffered formalin, phosphate buffered saline, 1% sodium dodecyl sulfate solution, 1% Tween 80 solution, elution solution, 2.5 M sucrose solution, Percoll-sucrose solution, the ethanol/glycerin dehydration series, DABCO-glycerin mounting medium, and 1% bovine serum albumin?		
Is the laboratory using Ensys's hydrofluor-combo kit for staining <i>Giardia</i> cysts and <i>Cryptosporidium</i> oocysts?		
Is the Ensys hydrofluor-combo kit still within the expiration time set by the manufacturer?		
Is the Percoll-sucrose solution used within a week of preparation?		
Is the elution solution used within a week of preparation?		
Is the DABCO-glycerin mounting medium discarded six months after preparation?		

<b>ICR Protozoan Laboratory Checklist</b>		
<b>Question</b>	<b>Answer</b>	
	<b>Yes</b>	<b>No</b>
Is the 1% bovine serum albumin discarded six months after preparation?		
Are disposable cutting tools used to cut the sampling filter down to the core?		
Are the disposable cutting tool blades reused?		
Is the sampling filter in either a glass or stainless steel pan of the appropriate size, while it is being cut to the core?		
Are the filter fibers divided appropriately before hand washing?		
Is the total hand washing time a minimum of 30 min?		
Is stomacher washing done in two five minute intervals with redistribution of the filter fibers between the intervals?		
Is the right amount of 10% neutral buffered formalin added to the concentrated particulates at the appropriate time?		
Are the concentrated particulates diluted appropriately before the Percoll-sucrose flotation?		
Is the Percoll-sucrose gradient prepared correctly in a clear conical centrifuge tube?		
Is a centrifugation nomograph for determining relative centrifugal force (gravities) located close to the centrifuge(s)?		
Is the Percoll-sucrose gradient centrifuged correctly with slow acceleration and deceleration?		
Is the Percoll-sucrose gradient interface harvested appropriately after centrifugation?		
Is the final volume of the interface 5 ml, when harvesting is complete?		
Are 5-mm diameter 12-well red teflon heavy coated slides used to determine the correct sample volume per filter in the IFA staining procedure?		
Is the sample volume per filter in the IFA staining procedure done correctly?		

<b>ICR Protozoan Laboratory Checklist</b>		
<b>Question</b>	<b>Answer</b>	
	<b>Yes</b>	<b>No</b>
Are support and Sartorius membranes handled with blunt end forceps initially?		
Are the support and Sartorius membranes properly hydrated before application to the manifold?		
Is the Hoefer manifold properly configured and adjusted before the addition of the support and Sartorius membranes?		
Do the Sartorius membrane filters the laboratory is using have a porosity between 0.2 and 1.2 $\mu\text{m}$ ?		
Is a positive and a negative <b>IFA Control</b> using a Sartorius filter run with each run of the manifold?		
Are the Hoefer manifold wells labelled well during the staining procedure?		
Does the sample application to the membranes on the manifold include rinses of the wells and membranes with 1% bovine serum albumin before and after application?		
Is the primary antibody diluted correctly with 1X phosphate buffered saline and goat serum?		
Is the right amount of primary antibody applied per membrane, and is it incubated for the correct amount of time?		
Is the primary antibody rinsed away correctly before the application of the secondary antibody?		
Is the secondary antibody diluted correctly?		
Is the right amount of secondary antibody applied per membrane, and is it incubated for the correct amount of time?		
Are the Hoefer manifold well weights covered with aluminum foil during the secondary antibody incubation?		
Is the secondary antibody rinsed away correctly after the incubation period?		
Is the alcohol dehydration step done correctly?		

ICR Protozoan Laboratory Checklist		
Question	Answer	
	Yes	No
Are the glass slides that are to receive the membranes from the manifold labelled in advance?		
Have the labelled glass slides been prewarmed for 20-30 min with 75 $\mu$ L of 2% DABCO-glycerin before the application of the membrane?		
Is a fresh, clean pair of forceps used to transfer each membrane from the Hoefer manifold to its respective glass slide?		
Is care exercised to insure that the Sartorius membranes are applied top side up to the slide?		
Are the membranes allowed to clear before application of the cover slip?		
Are the membranes flattened correctly, before sealing the cover slip?		
Are all the edges of the cover slip sealed well with clear nail polish?		
Is sample processing data being recorded as the method is being performed?		
Are the finished slides stored in an appropriate "dry-box"?		
Is the dry-box of slides allowed to reach room temperature before being opened?		
Is the microscope aligned and adjusted before the analysts starts scanning and reading slides?		
Is the scanning of the slides done appropriately, with the entire coverslip being scanned rather than just the membrane?		
Are measurements done with the 100X objective?		
Is the room in which the microscope is located darkened while the microscope is being used?		
Are the positive and negative control slides examined as prescribed in the method, including the complete examination of 3 <i>Giardia</i> cysts and 3 <i>Cryptosporidium</i> oocysts?		
Can the microscopist who is reading the sample slides easily change the optics from epifluorescence to Hoffman modulation or differential interference contrast optics?		



## ICR Protozoan Laboratory Checklist

Question	Answer	
	Yes	No
Are confirmations of internal structures within <i>Giardia</i> cysts and <i>Cryptosporidium</i> oocysts being confirmed by a principal analyst/supervisor.		
Is the microscopic data being entered onto the <i>Giardia</i> and <i>Cryptosporidium</i> report forms appropriately?		
Are the results from each sample being calculated on the provided computer spreadsheet?		
Are the computer spreadsheet files backed up on more than one disk, to insure data are not lost in the eventuality of some hardware failure?		
Are the Hoefler manifold and the stainless steel wells cleaned as prescribed in the method?		
Are the forceps used during the IFA staining cleaned well between uses?		
Is all glassware and plasticware washed well and stored appropriately between uses?		



**APPENDIX D. CHECKLIST FOR LABORATORY APPROVAL FOR  
TOTAL CULTURABLE VIRUS**

SECTION I - LABORATORY-SPECIFIC INFORMATION

<b>ICR Virus Laboratory Checklist</b>			
<b>Laboratory:</b>			
<b>Address:</b>			
<b>City:</b>	<b>State:</b>	<b>Zip:</b>	
<b>Type of Laboratory (Check):</b>			
<b>Commercial:</b>	<b>University:</b>	<b>Utility:</b>	<b>State:</b>
<b>Other (Describe):</b>			
<b>Principal Customers: (Check)</b>	<b>Environmental:</b>	<b>Clinical:</b>	
	<b>Other (Describe):</b>		
<b>Laboratory Contact Person:</b>			
<b>Title:</b>			
<b>Telephone:</b>		<b>Fax:</b>	
<b>Laboratory Evaluated by:</b>			<b>Date:</b>



### Codes for Marking Checklist

**S - Satisfactory**

**U - Unsatisfactory**

**NA- Not Applicable**

Item to be evaluated	Evaluation
<b>2. Laboratory Facilities</b>	
2.1 Laboratory rooms are clean, and temperature and humidity controlled	
2.2 Lighting at bench top is adequate	
2.3 Bench tops have smooth, impervious surfaces	
2.4 Working space per analyst is adequate	
2.5 Storage space is adequate	
2.6 Work is separated by room or by microbiological hoods	
<b>3. Laboratory Safety</b>	
3.1 Laboratory meets and follows "laboratory biosafety level 2 guidelines"	
3.2 Access to laboratory is limited	
3.3 Lab coats are used in the laboratory	
3.4 Mechanical pipetting devices are used	
3.5 Food is not stored or consumed in the laboratory	
3.6 Appropriate biohazard signs are placed on laboratory access doors	
3.7 A written biosafety manual is followed and available for inspection	
3.8 Laboratory personnel are adequately trained	
3.9 Laboratory has provision for disposal of microbiological wastes	
<b>4. Laboratory Equipment and Supplies</b>	
<b>4.1 Laboratory pH Meter</b>	
Manufacturer	Model
4.1.1 Accuracy $\pm$ 0.1 units; scale graduations, 0.1 units	
4.1.2 pH buffer solution aliquots are used only once	
4.1.3 Electrodes are maintained according to manufacturer's recommendations	

<b>Item to be evaluated</b>		<b>Evaluation</b>
	<b>4.1.4</b> Commercial buffer solutions are dated when received and discarded before expiration date	
<b>QC</b>	<b>4.1.5</b> A record of pH measurements and calibrations used is maintained	
<b>4.2 <i>Light Microscope</i></b>		
	Manufacturer	Model
	<b>4.2.1</b> Microscope is equipped with lenses to provide about 40X - 100X total magnification	
	<b>4.2.2</b> Optical clarity is good	
<b>4.3 <i>Inverted Light Microscope</i></b>		
	Manufacturer	Model
	<b>4.3.1</b> Microscope is equipped with lenses to provide about 40X - 100X total magnification	
	<b>4.3.2</b> Optical clarity is good	
<b>4.4 <i>Microbiological Hood</i></b>		
	Manufacturer	Model
	<b>4.4.1</b> Hood is at least a class II biological safety cabinet	
	<b>4.4.2</b> Hood is certified on an annual basis	
<b>4.5 <i>Temperature Monitoring</i></b>		
	<b>4.5.1</b> Glass/mercury, dial thermometers or continuous recording devices are used with appropriate equipment. Units are graduated in no more than 0.5°C increments. Mercury columns are not separated	
<b>QC</b>	<b>4.5.2</b> Calibration of glass/mercury thermometers is checked annually and dial thermometers quarterly at the temperature used against a reference NIST thermometer or one meeting the requirements of NIST Monograph SP 250-23	
<b>QC</b>	<b>4.5.3</b> Correction data are available for reference thermometers	
<b>QC</b>	<b>4.5.4</b> Continuous recording devices are recalibrated annually	

Item to be evaluated		Evaluation
<b>4.6 Incubator</b>		
Manufacturer	Model	
<b>4.6.1</b>	An internal temperature of $36.5 \pm 1^{\circ}\text{C}$ is maintained	
<b>4.6.2</b>	A temperature monitoring device is placed on a shelf near area of use. The bulb or probe of the temperature monitoring device is in liquid	
<b>QC 4.6.3</b>	Temperature is recorded at least once per day for each workday in use	
<b>4.7 Refrigerator</b>		
Manufacturer	Model	
<b>4.7.1</b>	An internal temperature of $1^{\circ}$ to $5^{\circ}\text{C}$ is maintained	
<b>4.7.2</b>	A temperature monitoring device is placed on a shelf near area of use. The bulb or probe of the temperature monitoring device is in liquid	
<b>QC 4.7.3</b>	Temperature is recorded at least once per day for each workday in use	
<b>4.8 Freezer, <math>-20^{\circ}\text{C}</math></b>		
Manufacturer	Model	
<b>4.8.1</b>	An internal temperature of $-20^{\circ} \pm 5^{\circ}\text{C}$ is maintained	
<b>4.8.2</b>	A temperature monitoring device is placed on a shelf near area of use.	
<b>QC 4.8.3</b>	Temperature is recorded at least once per day for each workday in use	
<b>4.9 Freezer, <math>-70^{\circ}\text{C}</math></b>		
Manufacturer	Model	
<b>4.9.1</b>	An internal temperature of $-70^{\circ} \pm 3^{\circ}\text{C}$ or lower is maintained	
<b>4.9.2</b>	A temperature monitoring device is placed on a shelf near area of use	



Item to be evaluated		Evaluation
QC 4.9.3	Temperature is recorded at least once per day for each workday in use	
<b>4.10 Refrigerated Centrifuge</b>		
Manufacturer		Model
4.10.1	Operates at a centrifugal force of at least 4,000 ×g	
4.10.2	Holds at 4°C during centrifugation run	
4.10.3	Appropriate rotor holds 100 - 1000 ml bottles	
QC 4.10.4	A log recording rotor serial number, run speed and time, run temperature and operator's initials is kept for each centrifugation run	
<b>4.11 Balance</b>		
Manufacturer		Model
QC 4.11.1	Balance is calibrated monthly	
QC 4.11.2	Correction data are available for S/S-1 calibration weights	
4.11.3	An annual service contract or internal maintenance protocol is maintained	
<b>4.12 Autoclave</b>		
Manufacturer		Model
4.12.1	Unit is equipped with a temperature gauge with sensor on exhaust	
4.12.2	Unit depressurizes slowly so that media do not boil over	
4.12.3	Unit's automatic timing mechanism is adequate	
4.12.4	A service contract or internal maintenance protocol is maintained	
4.12.5	A maximum temperature-registering thermometer or heat-sensitive tape is used with each cycle	
QC 4.12.6	Spore strips or ampoules are used on a monthly basis	
QC 4.12.7	Date, contents, sterilization time and temperature are recorded for each cycle	
<b>4.13 Hot Air Oven (if used)</b>		
Manufacturer		Model

Item to be evaluated		Evaluation
4.13.1	Hot air oven maintains temperature of 170 - 180°C for at least 2 h	
4.13.2	Bulb or probe of temperature monitoring device is placed in sand during use. Thermometer graduated in no more than 10°C increments	
QC 4.13.3	Date, sterilization time and temperature are recorded for each cycle	
<b>4.14 Pump</b>		
Manufacturer		Model
Pump is self-priming		
<b>4.15 Polypropylene Container</b>		
Manufacturer/Source		Model/Cat. No.
Container holds 40 L; contents can be mixed without spilling		
<b>4.16 Positive Pressure Source (record for source used)</b>		
Compressed air		
Compressed nitrogen		
Laboratory air source		
Manufacturer		Model
Peristaltic pump		
Manufacturer		Model
<b>4.17 Magnetic Stirrer</b>		
Manufacturer		Model
<b>4.18 Source for Reagent Grade Water</b>		
Type/Manufacturer		Model/Cat. #
4.18.1	Still or deionization unit is maintained according to manufacturer's instructions	
4.18.2	Reagent grade water is used to prepare all media and reagents	
QC 4.18.3	The conductivity is tested with each use. Conductivity is >0.5 megohms-cm at 25°C	

Item to be evaluated	Evaluation
<b>5. General Laboratory Practices</b>	
<b>5.1 Analytical Media</b>	
<b>5.1.1 General</b>	
5.1.1.1 Commercial media and chemicals are dated upon receipt. Only analytical reagent or ACS grade chemicals are used for preparation of media	
5.1.1.2 Commercial dehydrated or liquid media are used for propagation of tissue culture cells. Dehydrated media are prepared and stored as recommended by manufacturers.	
5.1.1.3 Commercial media and chemicals are discarded by manufacturers' expiration dates. Laboratory prepared media are discarded by the expiration dates indicated in the Virus Monitoring Protocol	
5.1.1.4 Each lot of medium is checked for sterility before use	
<b>QC</b> 5.1.1.5 Lot numbers of commercial media and chemicals are recorded. Date of preparation, type of medium, lot number, sterilization procedure, pH and technician's initials are recorded for laboratory prepared media	
<b>5.1.2 Thiosulfate (2%)</b>	
Solutions are stored at or below room temperature and discarded after six months	
<b>5.1.3 Hydrochloric acid</b>	
5.1.3.1 Solutions are prepared at least 24 h prior to use in sampling or virus assays	
5.1.3.2 Solutions are stored at or below room temperature and discarded after six months	
<b>5.1.4 Sodium Hydroxide</b>	
5.1.4.1 Solutions are prepared at least 24 h prior to use in virus assays	
5.1.4.2 Solutions are stored in polypropylene containers at room temperature and discarded after 3 months	
<b>5.1.5 Beef Extract (1.5%)</b>	
5.1.5.1 Final pH is 9.5	

Item to be evaluated	Evaluation
5.1.5.2 Solution is stored at 4°C and discarded after one week or at -20°C and discarded after 18 months	
<b>5.1.6 Sodium Phosphate</b>	
5.1.6.1 Final pH is between 9.0 and 9.5	
5.1.6.2 Solutions are stored at or below room temperature and discarded after six months	
<b>5.1.7 Washing Solution</b>	
5.1.7.1 Salt solution is cooled to room temperature before addition of serum	
5.1.7.2 Solutions are stored at 4°C and discarded after 3 months or at -20°C and discarded after 18 months	
<b>5.1.8 Chlorine</b>	
5.1.8.1 Final pH is between 6 and 7	
5.1.8.2 Solutions are stored at or below room temperature and discarded after one month	
<b>5.1.9 Iodine</b>	
Solutions are stored at room temperature and discarded after six months	
<b>5.2 Sterilization and Disinfection</b>	
5.2.1 Autoclavable glassware, plasticware and equipment are autoclaved at 121°C for 1 h or, if appropriate, sterilized by dry heat at 170°C for at least 1 h	
5.2.2 Non-autoclavable supplies are disinfected with 0.1% chlorine (pH 6-7) for 30 min or in a gas sterilizer according to the manufacturer's recommendations	
5.2.3 Contaminated materials are autoclaved at 121°C for at least 1 h	
5.2.4 Adequate glassware washing facilities are available for reusable lab ware	
5.2.5 Surfaces are disinfected before and after use and after spills	
<b>7. Quality Assurance</b>	
A written QA plan is followed and available for inspection	

SECTION II - ANALYST-SPECIFIC INFORMATION (To be filled out for each principal analyst/analyst/technician seeking approval for ICR virus analysis):

<b>Name of Analyst/Technician:</b>	
<b>Item to be evaluated</b>	<b>Evaluation</b>
<b>6. Analytical Methodology</b>	
<b>6.1 General</b>	
Only the virus analytical method dated July, 1995, is used for site visit evaluation	
<b>6.2 QC Samples</b>	
A polypropylene container and pump are used to pump a negative QC sample through a 1MDS filter in a standard sampling apparatus. All components of the system are sterile	
<b>6.3 Filter Elution</b>	
<b>6.3.1</b> Residual water is blown out from the cartridge housing before addition of beef extract	
<b>6.3.2</b> 1MDS filters are slowly eluted with 1.5% beef extract twice. The flow of beef extract is interrupted for 1 min during each pass to enhance elution	
<b>6.3.3</b> An air filter is used with a positive pressure lab air source	
<b>6.4 Organic Flocculation</b>	
<b>QC 6.4.1</b> The pH meter is standardized at pH 4 and 7	
<b>6.4.2</b> The pH electrode is disinfected before and after use	
<b>6.4.3</b> The pH of the eluate is adjusted slowly to $3.5 \pm 0.1$ with 1 M HCl with stirring at a speed sufficient to develop a vortex	
<b>6.4.4</b> The eluate is stirred for 30 min after pH adjustment	
<b>6.4.5</b> The pH adjusted eluate is centrifuged at $2,500 \times g$ for 15 min at $4^{\circ}\text{C}$ .	
<b>6.4.6</b> Supernatant from centrifuge run is properly discarded	
<b>6.4.7</b> Precipitate from centrifuge run is dissolved in 30 ml of 0.15 M sodium phosphate.	
<b>QC 6.4.8</b> The pH meter is standardized at pH 7.0 and 10.0	
<b>6.4.9</b> The pH electrode is disinfected before and after use	

<b>Name of Analyst/Technician:</b>		
<b>Item to be evaluated</b>		<b>Evaluation</b>
<b>6.4.10</b>	The pH of the dissolved precipitate is checked and readjusted to 9.0-9.5, if necessary	
<b>6.4.11</b>	The dissolved precipitate is centrifuged at 4,000-10,000 ×g for 10 min at 4°C	
<b>6.4.12</b>	The supernatant from the 4,000-10,000 ×g run is saved and the precipitate properly discarded	
<b>6.4.13</b>	The pH of the supernatant is adjusted to 7.0-7.5 with 1 M HCl	
<b>6.4.14</b>	The supernatant is treated to remove or reduce microbial contamination. Sterilizing filters are pretreated before use with beef extract	
<b>6.4.15</b>	The final volume is recorded after treatment	
<b>6.4.16</b>	The treated supernatant is divided into subsamples.	
<b>6.5 Total Culturable Virus Assay</b>		
<b>QC 6.5.1</b>	Passage 117 to 250 BGM cells from the U.S. EPA are being cultured for ICR virus assays	
<b>6.5.2</b>	Cultures are used 3-6 days after passage. Cultures are washed prior to inoculation with serum free medium	
<b>6.5.3</b>	At least 10 replicate cultures per subsample or subsample dilution are inoculated with a proper inoculation volume	
<b>6.5.4</b>	Inoculation volume does not exceed 0.04 ml/cm <sup>2</sup>	
<b>6.5.5</b>	An adsorption period of 80-120 min is used. Adsorption occurs at 22 to 36.5 ± 1°C	
<b>6.5.6</b>	Liquid maintenance medium is added and cultures are incubated at 36.5 ± 1°C	
<b>6.5.7</b>	A 2nd passage is performed using 10% of the medium from the 1st passage. Samples positive in the 1st passage are filtered prior to passage	
<b>6.5.8</b>	Analyst demonstrates ability to perform MPN calculations	
<b>6.5.9</b>	A positive and negative control is run with each sample	

## DESCRIPTION OF CHECKLIST FOR LAB APPROVAL FOR VIRUS ANALYSIS

*Note:* Written records must be retained for five years for quality control items designated as "QC".

### **1. Personnel**

#### **1.1 *Principal Analyst/Supervisor***

The principal analyst/supervisor is a qualified microbiologist with experience with environmental virology. The principal analyst/supervisor oversees all analyses of samples for viruses.

**1.1.1 Academic Training:** Minimum of a bachelor's degree in the life sciences.

**1.1.2 Job Training:** Minimum of three years experience in cell culture and animal virus analyses.

#### **1.2 *Analyst***

The analyst performs at the bench level with minimal supervision and is involved in all aspects of the analysis, including sample collection, filter extraction, sample processing and assay.

**1.2.1 Academic Training:** Minimum of two years of full time college with a major in life science.

**1.2.2 Job Training:** Minimum of six months of full-time bench experience in cell culture and animal virus analyses.

#### **1.3 *Technician***

The technician extracts the filter and processes samples, but does not perform tissue culture work.

**1.3.1 Academic Training:** No requirements.

**1.3.2 Job Training:** Three months experience in filter extraction of virus samples and sample processing.

### **2. Laboratory Facilities**

**2.1** Laboratory facilities are temperature and humidity controlled. Laboratories are clean; a pest control program is in place, if appropriate.

**2.2** Work surfaces have adequate lighting (minimum of 100 foot-candles).

**2.3** Laboratory bench tops have smooth, impervious surfaces.

**2.4** There is at least six to ten linear feet of usable bench space per analyst with a minimum of 36-38 inches of depth.

**2.5** There is sufficient laboratory space for storage of media, glassware and equipment.

**2.6** Filter extraction/sample processing is performed in a separate laboratory room from cell culture and virus work. Cell culture and virus work are performed in separate rooms or in separate microbiological hoods. A program is in place to ensure that no cross-contamination occurs if the latter is used.

### **3. Laboratory Safety**

**3.1** The laboratory meets and follows laboratory biosafety level 2 guidelines.

**3.2** Laboratories have limited access.

**3.3** Lab coats are worn while working in laboratories.

**3.4** Mouth pipetting is not allowed in the laboratory.

**3.5** Food and drinks are not stored or consumed in the laboratory.

**3.6** Biohazard signs identifying biohazards are placed on the laboratory access doors.

**3.7** A written biosafety manual is followed and available for inspection.

**3.8** Laboratory personnel have been given laboratory safety training.

**3.9** The laboratory is in compliance with all applicable judicial ordinances and laws for virus work and biological waste disposal.

### **4. Laboratory Equipment and Supplies**

#### **4.1 pH Meters**

**4.1.1** The accuracy and scale graduations of a laboratory pH meter are within  $\pm 0.1$  pH units. The accuracy and scale graduations of a portable pH meter for use with water sampling are within  $\pm 0.2$  pH units.

**4.1.2** pH buffer aliquots are used only once.

**4.1.3** Electrodes are maintained according to the manufacturer's recommendations.



**QC 4.1.4** Commercial buffer solution containers are dated upon receipt and when opened. Solutions are discarded before the expiration date.

#### **4.2 *Light Microscope***

**4.2.1** The microscope is equipped with lenses to provide about 40X to 100X total magnification.

**4.2.2** Optical clarity is sufficient to accurately count cells in a hemocytometer.

#### **4.3 *Inverted Light Microscope***

**4.3.1** The microscope is equipped with lenses to provide about 40X to 100X total magnification.

**4.3.2** Optical clarity is sufficient to accurately demonstrate CPE.

#### **4.4 *Microbiological hood*** (if separate work areas are not available)

**4.4.1** Hood is at least a class II biological safety cabinet.

**QC 4.4.2** Hood is certified to be in proper operating condition on at least an annual basis.

#### **4.5 *Temperature Monitoring***

**4.5.1** Glass/mercury, dial thermometers or continuous recording devices are used to monitor equipment. Units are graduated in 0.5°C increments or less. Mercury columns in glass thermometers are not separated.

**QC 4.5.2** The calibration at the temperature used of each glass/mercury thermometer is checked annually against a reference National Institute of Standards and Technology (formerly National Bureau of Standards) (NBS) thermometer or one that meets the requirements of NIST Monograph SP 250-23. The calibration of each in-use dial thermometer is checked quarterly.

**QC 4.5.3** Correction data are available for all reference thermometers used for calibration.

**QC 4.5.4** Continuous recording devices are recalibrated annually using the reference thermometer described in QC 4.5.2.

#### **4.6 *Incubator***

**4.6.1** The incubator maintains an internal temperature of  $36.5 \pm 1^\circ\text{C}$ .

**4.6.2** A temperature monitoring device is placed on a shelf near area of use. The bulb or probe of the temperature monitoring device is in liquid.

**QC 4.6.3** The temperature is recorded at least once per day for each workday in use.

#### **4.7 Refrigerator**

**4.7.1** The refrigerator maintains a temperature of 1° to 5°C.

**4.7.2** A calibrated temperature monitoring device is placed on a shelf near the area of use. The thermometer bulb or probe is immersed in liquid.

**QC 4.7.3** The temperature is recorded at least once per day for each workday in use.

#### **4.8 Freezer, -20°C**

**4.8.1** The freezer maintains a temperature of  $-20 \pm 5^\circ\text{C}$ . The freezer may be a compartment associated with 4.6.

**4.8.2** A calibrated temperature monitoring device is placed on a shelf near the area of use.

**QC 4.8.3** The temperature is recorded at least once per day for each workday in use.

#### **4.9 Freezer, -70 °C**

**4.9.1** The freezer maintains a temperature of  $-70 \pm 3^\circ\text{C}$  or lower.

**4.9.2** A calibrated temperature monitoring device is placed on a shelf near the area of use.

**QC 4.9.3** The temperature is recorded continuously during periods of use or at least once per day for each workday in use.

#### **4.10 Refrigerated Centrifuge**

**4.10.1** The centrifuge can be operated at a centrifugal force of at least  $4,000 \times g$ .

**4.10.2** Centrifuge maintains an internal temperature of 4°C during run.

**4.10.3** A rotor is available which is capable of  $4,000 \times g$  while holding centrifuge bottles of 100 - 1000 ml.

QC 4.10.4 A log recording rotor serial number, run speed, time of centrifugation, temperature of operation and operator is kept for each centrifuge run.

#### 4.11 *Balance*

QC 4.11.1 The balance is calibrated monthly using Class S or S-1 reference weights (minimum of three traceable weights which bracket laboratory weighing needs) or weights traceable to Class S or S-1 weights.

QC 4.11.2 Correction data are available for the S or S-1 calibration weights.

4.11.3 A service contract or internal maintenance protocol is established and records are maintained.

#### 4.12 *Autoclave*

4.12.1 The autoclave has a temperature gauge with a sensor on the exhaust, a pressure gauge and an operational safety valve.

4.12.2 Autoclave depressurizes slowly to ensure that media do not boil over.

4.12.3 The autoclave's automatic timing mechanism is adequate. The autoclave maintains sterilization temperature during the sterilizing cycle and completes an entire liquid cycle within 45 min when a 12-15 min sterilization period is used.

4.12.4 A service contract or internal maintenance protocol is established and records are maintained.

4.12.5 A maximum temperature-registering thermometer or heat-sensitive tape is used with each autoclave cycle.

QC 4.12.6 Spore strips or ampules are used on a monthly basis.

QC 4.12.7 The date, contents, sterilization time and temperature is recorded for each cycle.

#### 4.13 *Hot Air Oven* (If used for sterilizing dry glassware.)

4.13.1 The oven maintains a stable sterilization temperature of 170 - 180°C for at least two h.

4.13.2 A temperature monitoring device is used with the bulb or probe placed in sand during use. The monitoring device is graduated in no more than 10°C increments.

**QC 4.13.3** The date, contents, sterilization time and temperature is recorded for each cycle.

#### **4.14 *Pump***

A self-priming pump is required for preparation of QC samples. It is recommended that the pump be capable of pumping at a rate of 3 gal/min at 30 PSI.

#### **4.15 *Polypropylene Container***

The container holds at least 40 L. The contents can be mixed without spilling or splashing.

#### **4.16 *Positive Pressure Source***

An air or nitrogen source and pressure vessel or a peristaltic type pump is used for filter elution.

#### **4.17 *Magnetic Stirrer***

The magnetic stirrer is capable of maintaining a vortex during organic flocculation and pH adjustments.

#### **4.18 *Source for Reagent Grade Water***

**4.18.1** Distillation and/or deionization units are maintained according to the manufacturer's instructions or water is purchased commercially.

**4.18.2** Reagent grade water is used to prepare all media and reagents.

**QC 4.18.3** The conductivity of the reagent grade water is tested with each use. The conductivity is  $>0.5$  megohms-cm at 25°C.

### **5. General Laboratory Practices**

#### **5.1 *Analytical Media***

##### **5.1.1 General**

5.1.1.1 Commercial media and chemicals are dated upon receipt and when first opened. Only analytical reagent or ACS grade chemicals are used for the preparation of media.

5.1.1.2 Use of commercial dehydrated or liquid media for propagation of tissue culture cells are recommended due to concern about quality control. Dehydrated media are prepared and stored as recommended by the manufacturers.

5.1.1.3 Commercial media and chemicals are discarded by manufacturers' expiration dates. Laboratory prepared media are discarded by the expiration dates indicated in the Virus Monitoring Protocol.

5.1.1.4 Each lot of medium is checked for sterility before use as described in the Virus Monitoring Protocol.

QC 5.1.1.5 The lot numbers of commercial media and chemicals are recorded. The date of preparation, type of medium, lot number, sterilization procedure, pH and technician's initials are recorded for media prepared in the laboratory.

### **5.1.2 Thiosulfate (2%)**

5.1.2.1 A stock solution of 2% thiosulfate is prepared by dissolving 100 g of  $\text{Na}_2\text{S}_2\text{O}_3$  in a total of 5000 ml of reagent grade water. The solution is autoclaved for 30 min at 121 °C.

5.1.2.2 2% thiosulfate is stored at or below room temperature for up to six months.

### **5.1.3 Hydrochloric acid (HCl)**

5.1.3.1 Solutions of 0.1, 1 and 5 M HCl are prepared by mixing 50, 100 or 50 ml of concentrated HCl with 4950, 900 or 50 ml of reagent grade water, respectively. Solutions of HCl are self-sterilizing and should be prepared at least 24 h prior to use.

5.1.3.2 Solutions of HCl are stored at or below room temperature for up to six months.

### **5.1.4 Sodium Hydroxide (NaOH)**

5.1.4.1 Solutions of 1 M and 5 M NaOH are prepared by dissolving 4 or 20 g of NaOH in a final volume of 100 ml of reagent grade water, respectively. Solutions of NaOH are self-sterilizing and should be prepared at least 24 h prior to use.

5.1.4.2 Solutions of NaOH are stored in polypropylene containers at room temperature for up to three months.

### **5.1.5 Beef Extract, 1.5%**

5.1.5.1 Buffered 1.5% beef extract is prepared by dissolving 30 g of beef extract V powder and 7.5 g of glycine (final glycine concentration = 0.05 M) in 1.9 L of reagent grade water. The pH is adjusted to 9.5 with 1 or 5 M NaOH and the final

volume is brought to 2 L with reagent grade water. The solution is autoclaved at 121 °C for 15 min.

5.1.5.2 Solutions of 1.5% beef extract are stored for one week at 4 °C or for up to 18 months at -20 °C.

### **5.1.6 Sodium Phosphate, 0.15 M**

5.1.6.1 A solution of 0.15 M sodium phosphate is prepared by dissolving 40.2 g of sodium phosphate ( $\text{Na}_2\text{HPO}_4 \cdot 7\text{H}_2\text{O}$ ) in a final volume of 1000 ml of reagent grade water. The pH is checked to ensure that it is between 9.0 - 9.5 and adjusted with 1 M NaOH, if necessary. The solution is autoclaved at 121 °C for 15 min.

5.1.6.2 Solutions of 0.15 M sodium phosphate are stored at or below room temperature for up to six months.

### **5.1.7 Washing Solution**

5.1.7.1 Washing solution is prepared by dissolving 8.5 g of NaCl in a final volume of 980 ml of reagent grade water. The solution is autoclaved at 121 °C for 15 min and cooled to room temperature. 20 ml of bovine serum is added and the solution is mixed thoroughly.

5.1.7.2 The wash solution is stored at 4 °C for up to three months or at -20 °C for up to 18 months.

### **5.1.8 Chlorine, 0.1%**

5.1.8.1 A solution of 0.1% chlorine (HOCl) is prepared by adding 19 ml of household bleach to 900 ml of reagent grade water, adjusting the pH of the solution to 6-7 with 1 M HCl and bringing the final volume to 1 L with reagent grade water. Solutions of 0.1% chlorine are self-sterilizing.

5.1.8.2 Solutions of 0.1% chlorine are stored at or below room temperature for up to one month.

### **5.1.9 Iodine, 0.5%**

5.1.9.1 A solution of 0.5% iodine is prepared by dissolving 5 g  $\text{I}_2$  in 1000 ml of 70% ethanol. Solutions of 0.5% iodine are self-sterilizing.

5.1.9.2 Solutions of 0.5% iodine are stored at room temperature for up to six months.

## **5.2 *Sterilization and Disinfection***

**5.2.1** Autoclavable glassware, plasticware and equipment are sterilized by autoclaving at 121 °C for 1 h or, if appropriate, by dry heat at 170 °C for at least one h.

**5.2.2** Non-autoclavable supplies are disinfected with 0.1% chlorine (pH 6-7) for 30 min or in a gas sterilizer according to the manufacturer's instructions.

**5.2.3** Contaminated materials are sterilized by autoclaving at 121 °C for at least 1 h.

**5.2.4** Adequate glassware washing facilities are available for washing re-usable glassware.

**5.2.5** All surfaces are disinfected with 0.5% iodine or 0.1% chlorine, pH 6-7 before and after each use and after any spill or other contamination.

## **6. *Analytical Methodology***

### **6.1 *General***

Only the analytical methodology specified in the July, 1995, draft of the *Virus Monitoring Protocol for the Information Collection Rule* is used for lab and analyst approval.

### **6.2 *QC Samples***

**QC** Each analyst and technician must prepare and process a negative QC sample during the site visit (technicians will only be required to perform steps 6.3 to 6.4). A negative QC sample is prepared by pumping 40 L of reagent grade water placed in a sterile polypropylene container through a sterile standard sampling apparatus.

### **6.3 *Filter Elution***

**6.3.1** Residual water is blown out from the cartridge housing.

**6.3.2** Virus is eluted from the 1MDS filter by slowly passing 1000 ml of 1.5% beef extract (pH 9.5) through the filter twice. The flow of beef extract is interrupted for 1 min during each pass to enhance elution.

**6.3.3** An air filter is used with a positive pressure lab air source.

## **6.4 *Organic Flocculation***

- QC 6.4.1** The pH meter is standardized at pH 4 and 7.
- 6.4.2** The pH electrode is disinfected before and after use.
- 6.4.3** The pH of the eluate is adjusted slowly to  $3.5 \pm 0.1$  with 1 M HCl with stirring at a speed sufficient to develop a vortex.
- 6.4.4** The eluate is stirred for 30 min after pH adjustment.
- 6.4.5** The pH adjusted eluate is centrifuged at  $2,500 \times g$  for 15 min at  $4^{\circ}\text{C}$ .
- 6.4.6** The supernatant is properly discarded after the centrifugation run.
- 6.4.7** The precipitate is dissolved in 30 ml of 0.15 M sodium phosphate.
- QC 6.4.8** The pH meter is standardized at pH 7 and 10.
- 6.4.9** The pH electrode is disinfected before and after use.
- 6.4.10** The pH of the dissolved precipitate is readjusted to 9.0 - 9.5, if necessary.
- 6.4.11** The dissolved precipitate is centrifuged at  $4,000 - 10,000 \times g$  for 10 min at  $4^{\circ}\text{C}$ .
- 6.4.12** The supernatant is removed and saved after the centrifugation run. The pellet is properly discarded.
- 6.4.13** The pH of the supernatant is adjusted to 7.0 - 7.5 with 1 M HCl.
- 6.4.14** The supernatant is treated to remove or reduce microbial contamination. Sterilizing filters are pretreated before use with beef extract.
- 6.4.15** The final volume is recorded after treatment.
- 6.4.16** The treated supernatant is divided into subsamples.

## **6.5 *Total Culturable Virus Assay***

- QC 6.5.1** Passage 117 to 250 BGM cell cultures obtained from the U.S. EPA are being cultured for ICR virus assays.



**6.5.2** Cultures are used between three and six days after the most recent passage or the laboratory has demonstrated that the culture time used is as sensitive as cultures at three to six days. Cultures are washed prior to inoculation with serum-free medium.

**6.5.3** At least ten replicate cultures per subsample or subsample dilution are inoculated with an inoculation volume equal to 1/20th the assay sample volume.

**6.4.4** The inoculation volume does not exceed 0.04 ml/cm<sup>2</sup>.

**6.5.5** Virus is allowed to adsorb onto cells for 80 - 120 min at room temperature or at 36.5 ± 1 °C.

**6.5.6** Liquid maintenance medium is added and cultures are incubated at 36.5 ± 1 °C.

**6.5.7** A 2nd passage is performed using 10% of the medium from the 1st passage. Samples that were positive in the 1st passage are filtered before doing the 2nd passage.

**6.5.8** The analyst demonstrates the ability to perform MPN calculations.

**6.5.9** A positive and negative control is run with each sample.

## **7. Quality Assurance**

The laboratory prepares and follows a written QA plan which is available for inspection during the site visit.